

Price List 2025



PVC-U thermoformed pipes
and fittings



Transport of pressurised fluids



Indice

General information

How to read the commercial codes of Lareter pipes	pag. 2
How to read the commercial codes of Lareter fittings	pag. 5
General characteristics	pag. 6
Reference standard	pag. 10
Approvals and quality marks	pag. 11

PIPES

Pipe Dimensional Tables PVC-U RAL 7011	pag. 13
Pipe Dimensional Tables PVC-U Transparen	pag. 33

FITTINGS

Dimensional tables Bends and Fittings	pag. 37
Spare parts and accessories	pag. 68
Conditions of supply	pag. 72

Codes

How to read the commercial codes of Lareter pipes

Es: **PIPEV2604006L** Pipe, PVC-U, SDR 26, Diam. 40, smooth, 6 mt, Brand Lareter

PIPE PRODUCT	V MATERIAL	26 SDR		040 DIAMETER		0 TYPE OF JOINT	6 BAR LENGTH	L BRAND		
				METRIC SERIES d (mm)	SERIES INCHES d/R (inches)					
PIPE pipe	V PVC-U	09	SDR 09	016	16	014	1/4"	0 plain end	0 5 meters	L Lareter
	U PVCU-NF	11	SDR 11	020	20	038	3/8"	I solvent socket	2 2 meters	
	T PVC-TRANSPARENT	13	SDR 13	025	25	012	1/2"	S Rubber ring socket (EPDM)	3 3 meters	
		15	SDR 15	032	32	034	3/4"	F Forsheda ring socket (PP-EPDM)	4 4 meters	
		17	SDR 17	040	40	100	1"	T threadable	6 6 meters	
		21	SDR 21	050	50	114	1 1/4"			
		26	SDR 26	063	63	112	1 1/2"			
		33	SDR 33			200	2"			
		41	SDR 41	075	75					
		BSC	Class BS C			212	2 1/2"			
		BSD	Class BS D	090	90					
		BSE	Class BS E	110	110	300	3"			
		BS7	Class BS 7	125	125	400	4"			
		T10	Threadable PN10	140	140					
		T16	Threadable PN16	160	160	500	5"			
		T16	Threadable PN16	180	180	600	6"			
				200	200					
				225	225					
				250	250	800	8"			
				280	280					
				315	315	810	10"			
				355	355	812	12"			
				400	400					
				500	500					

Codes

How to read the commercial codes of Lareter bends

Es: **PBVPN10063FIL** Bend in PVC-U, PN 10, Diam. 63, gasket Forsheda, degrees 11°, Brand Lareter

PB PRODUCT	V MATERIALE	PN 10 OPERATING PRESSURE	063 DIAMETER		F TYPE OF JOINT	1 TILT ANGLE	L BRAND	
			METRIC SERIES	d (mm)				
PB bend	V PVC-U	PN08 8 bar	063	63	O	smooth ISO male	1 11 degrees	L Lareter
		PN10 10 bar	075	75	I	ISO female	2 22 degrees	
		PN12 12 bar	090	90	F	Forsheda	3 30 degrees	
		PN16 16 bar	110	110	B	flanged ISO	4 45 degrees	
		PN20 20 bar	125	125	T	threadable	9 90 degrees	
			140	140	S	Rubber ring socket (EPDM)		
			160	160	O	smooth ISO male		
			180	180	I	ISO female		
			200	200	F	Forsheda		
			225	225	B	flanged ISO		
			250	250	T	threadable		
			280	280	S	Rubber ring socket (EPDM)		
			315	315				
	355	355						
	400	400						

Codes

How to read the commercial codes of Lareter sleeves

Es: **MANVPN10050SSL** Sleeve, PVC-U, PN10 , Diam. 50, **Rubber ring socket (EPDM)**, Brand Lareter

MAN PRODUCT	V MATERIAL	PN 10 OPERATING PRESSURE	050 DIAMETER		SS TYPE OF JOINT	L BRAND
				METRIC SERIES d (mm)		
MAN sleeve	V PVC-U	PN08 8 bar	050	50	O smooth ISO male	L Lareter
MAR sleeve long		PN10 10 bar	063	63	I ISO female	
		PN12 12 bar	075	75	F Forsheda	
		PN16 16 bar	090	90	B flanged ISO	
		PN20 20 bar	110	110	T threadable	
			125	125	S Rubber ring socket (EPDM)	
			140	140	O smooth ISO male	
			160	160	I ISO female	
			180	180	F Forsheda	
			200	200	B flanged ISO	
			225	225	T threadable	
			250	250	S Rubber ring socket (EPDM)	
			280	280		
			315	315		
			355	355		
			400	400		

Codes

How to read the commercial codes of Lareter joints

Es: **MGVP100630FL** Joint, PVC-U, P10, Diam. 63, smooth ISO male, Forsheda, Brand Lareter

MG PRODUCT	V MATERIAL	P 10 OPERATING PRESSURE	063 DIAMETER		OF TYPE OF JOINT	L BRAND	
			METRIC SERIES d (mm)	REDUCTION (ONLY IF PRESENT)			
MD MARID	V PVC-U	P00 FOR VALVE	050	50	050 50	O smooth ISO male	L Lareter
MG MONOG		P05 PN 5	063	63	063 63	I ISO female	
TP TOULIPE		P08 PN 8	075	75	075 75	F Forsheda	
TR REDUCED TOULIPE		P10 PN 10	090	90	090 90	B flanged ISO	
BO BOUT		P12 PN 12,5	110	110	110 110	T threadable	
RE REDUCER		P16 PN 16	125	125	125 125	S Rubber ring socket (EPDM)	
AU INCREASE		P20 PN 20	140	140	140 140	O smooth ISO male	
T9 TEE 90			160	160	160 160	I ISO female	
TR REDUCED TEE			180	180	180 180	F Forsheda	
TF FLANGED TEE			200	200	200 200	B flanged ISO	
TG GLUING TEE			225	225	225 225	T threadable	
B9 BEND 90 R1,5			250	250	250 250	S Rubber ring socket (EPDM)	
B4 BEND 45 R1,5			280	280	280 280		
SE GATE			315	315	315 315		
CL CLAPET VALVE			355	355	355 355		
IT LINE HYDRANT			400	400	400 400		
IS INLET HYDRANT							
IL END OF LINE HYDRANT							

General characteristics

Pipe size table



Rigid PVC-U pipes for pressurised fluid pipes with Forsheda gasket

RAL 7011 dark grey colour. Standard total length of 6 m. including gasket joint or gasket joint pre-inserted and locked FORSHEDA 601 POWER-LOCK® or glue joint or smooth bar.

Compliance mark: Lareter rigid PVC pipes for pressure pipes are guaranteed by the certifications issued by IIP, CSTB, DVGW, WRAS and IMO.

The pipes can be supplied in different colours (blue, orange, yellow...) and with different lengths (from 9 m to 0.15 m).



Øe mm	PN 6		PN 10			PN 12.5
	 th mm	 th mm	 th mm	 th mm	 th mm	 th mm
16	-	-	-	-	-	-
20	-	-	-	-	-	-
25	-	-	-	-	-	1.5
32	-	-	1.6	-	1.6	1.9
40	1.5	-	1.9	-	1.9	2.4*
50	1.6	-	2.4	-	2.4	3.0*
63	2.0	-	3.0	3.0	3.0	3.8*
75	2.3	-	3.6	3.6	3.6	4.5*
90	2.8	-	4.3	4.3	4.3	5.4*
110	2.7	3.2*	4.2	5.3	5.3	5.3
125	3.1	3.7*	4.8	6.0	6.0	6.0
140	3.5	3.7*	5.4	6.1	6.7	6.7
160	4.0	4.0*	6.2	6.2	7.7	7.7
180	4.4	4.4*	6.9	6.9	8.6	8.6*
200	4.9	4.9*	7.7	7.7	9.6	9.6*
225	5.5	5.5*	8.6	8.6	10.8	10.8*
250	6.2	6.2*	9.6	9.6	11.9	11.9*
280	6.9	-	10.7	-	13.4	13.4*
315	7.7	7.7*	12.1	12.1	15.0	15.0*
355	8.7	-	13.6	-	16.9	16.9*
400	9.8	9.8*	15.3	15.3	19.1	19.1*
500	12.3	12.3*	19.1	19.1	23.9	23.9*

* Upon request



UNI EN ISO 1452-2
PN 6 - 10 - 12.5 - 16 - 20
d 16 - 500 mm







NF EN 1452
PN 6 - 10 - 16 - 25
d 16 - 315 mm



DIN-8061 - 62
Reihe 4, Reihe 5
PN 10 - 16
d 16 - 500 mm



Øe mm	PN 16			PN 20	PN 25	Packaging No. pipes/pallet	Useful length	
	 th mm	 th mm	 th mm	 th mm	 th mm		Ring mt	Solvent welding mt
16	-	-	-	1.5	1.8	Bulk	-	-
20	1.5	-	1.5	1.9*	2.3	1166	-	5.96
25	1.9	-	1.9	2.3*	2.8	757	-	5.96
32	2.4	2.4	2.4	2.9*	3.6	449	-	5.93
40	3	3	3	3.7*	4.5	275	5.90	5.93
50	3.7	3.7	3.7	4.6*	5.6*	194	5.90	5.91
63	4.7	4.7	4.7	5.8*	7.1*	123	5.89	5.91
75	5.6	5.6	5.6	6.8*	-	87	5.88	5.89
90	6.7	6.7	6.7	8.2*	-	96	5.87	5.87
110	6.6	8.1	8.1	8.1*	-	57	5.87	5.86
125	7.4	9.2	9.2	9.2*	-	51	5.85	5.85
140	8.3	9.3	10.3	10.3*	-	45	5.84	5.83
160	9.5	9.5	11.8	11.8*	-	33	5.83	5.82
180	10.7	10.7	13.3	13.3*	-	28	5.83	5.82
200	11.9	11.9	14.7	14.7*	-	20	5.82	5.8
225	13.4	13.4	16.6	16.6*	-	18	5.8	5.78
250	14.8	14.8	18.4	18.4*	-	12	5.79	5.80
280	16.6	-	20.6*	20.6*	-	11	5.79	5.80
315	18.7	18.7	-	-	-	9	5.77	5.76
355	21.1*	-	-	-	-	6	5.75	5.72
400	23.7*	23.7*	-	-	-	5	5.75	5.72
500	29.7*	-	-	-	-	2	5.74	5.65

* Upon request



BV IMO A.753 (18)
Ø 16 - 315
PN 6 - PN 10 - PN 12.5 -
PN 16 - PN 20



UNI EN ISO 9001



UNI EN ISO 14001



ISO 45001

General characteristics

Dimensional table of threadable pipes

Standard PVC-U threadable pipes in bars of mt. 5 smooth. Quotation for thread, colour, different lengths on request.

DN inches	Øe mm	PN 10 th mm	PN 16 th mm	Packaging Tubes/pallet
3/8"	17.1	-	2.6	Bulk
1/2"	21.2	2.6	3	1103
3/4"	26.6	2.6	3.4	664
1"	33.4	3.3	4.3	436
1" 1/4	42.1	3.7	5	292
1" 1/2	48.1	4	5.4	207
2"	60.2	4.6	6.4	252
2"1/2	75	5.3	-	87
3"	88.7	6	-	96
4"	114.1	7	-	67



Pressure U-PVC pipes

BS-EN 1452, BS 3505

Pipes for aqueducts, wastewater, sewage and chemical applications. Dimensions in inches according to EN 1452 BS 3505 standards.

Grey RAL 7011 colour, standard length 6 metres with smooth or threadable ends.

Use for public water supply is certified by WRAS.



Øe inches	PN 9/CLASS C th mm	PN 12/CLASS D th mm	PN 15/CLASS E th mm	CLASS 7 th mm	Packaging Tubes/pallet
3/8"	-	-	1.5	-	Bulk
1/2"	-	-	1.7	3.7	1103
3/4"	-	-	1.9	3.9	664
1"	-	-	2.2	4.5	436
1" 1/4	-	2.2	2.7	4.8	292
1" 1/2	-	2.5	3.1	5.1	207
2"	2.5	3.1	3.9	5.5	252
2" 1/2	3	-	4.8	-	87
3"	3.5	4.6	5.7	-	96
4"	4.5	6	7.3	-	67
5"	5.5	-	-	-	45
6"	6.6	8.8	10.8	-	30
8"	7.8	-	-	-	18



Reference standards

PVC-U

Production of the PVC-U lines is carried out according to the highest quality standards and in full compliance with the environmental restrictions set by the applicable laws in force and in accordance with **ISO 14001**.

All products are made in accordance with the quality guarantee system in compliance with **ISO 9001**.

- **ASTM D 1784 cl. 12454**

Rigid PVC-U compound (for industrial applications)

- **ASTM D 1785**

Standard specification for pipes in PVC, Sch. 40-80-120

- **BS 3505**

PVC-U pipes for cold water

- **EN 10226-1/2**

Pipe threads, where pressure-tight joints are made on the threads - Part 2:

Tapered external threads and tapered internal threads - Dimensions, tolerances

- **DIN 8061**

PVC-U pipes: General quality and testing requirements

- **DIN 8062**

Dimensions of PVC-U pipes

- **DVS 2204 - DVS 2221**

Solvent welding of thermoplastic materials PVC-U

- **EN ISO 1452**

Characteristics of fittings and pipes in PVC-U for piping systems intended for water supply

- **EN ISO 15493**

Component systems (Tubes, Fittings and Valves) in ABS, PVC-U, PVC-C for industrial applications

- **ISO 161-1**

Dimensions of PVC-U pipes and fittings - metric series

- **ISO 727**

PVC-U pipes and fittings. Dimensions and tolerances, metric series

- **UNI 11242**

Solvent welding of PVC-U PVC-C pipes, fittings and valves

Approvals and quality marks



- **ACS France (Attestation de conformité Sanitaire)**

Suitability of PVC-U for application with water intended for human consumption



- **Bureau Veritas**

Suitability of PVC-U for conveyance, sanitary water treatment and air conditioning in the naval sector



- **CSTB PVC-U**

pipe and fittings in accordance with NF T 54-028



- **IIP Italian Institute of Plastics PVC-U**

pipe and fittings in accordance with UNI EN ISO 1452



- **WRAS (Water regulations advisory scheme - UK)**

Suitability of PVC-U and PVC-C for the transport of drinking water (Water Regulation Advisory Scheme - UK)



- **DVGW (Deutscher Verein des Gas und Wasserfaches)**

Potability issued by the Hygiene-Institut on behalf of DVGW

ISO PIPE

PRESSURE PIPE



ISO PIPE

Pressure pipes for joint system by cold chemical welding (gluing through the use of suitable WELD-ON adhesive and detergent primer) or FORSHEDA 601 POWERLOCK® pre-inserted and locked gasket joint.

Lareter rigid PVC pipes for pressure pipes are guaranteed by the certifications issued by IIP, CSTB, DVGW, WRAS and IMO.

PRESSURE PIPE

Technical specifications	
Size range	d 16 - d 500 (mm)
Nominal pressure	PN 6-10-12,5-16-20-25 with water at 20° C
Temperature range	0 °C ÷ 60 °C
Coupling standards	Solvent welding: EN ISO 15493, EN ISO 1452, DIN 8061/2. Coupling: Forsheda 601 POWER-LOCK® Gasket
Reference standards	Construction criteria: EN ISO 15493, EN ISO 1452, DIN 8061/2 Test methods and requirements: EN ISO 15493, EN ISO 1452, DIN 8061/2 Installation criteria: DVS 2204, DVS 2221, UNI 11242, EN ISO 1452, DIN 8061/2
Pipe material	PVC-U dark grey RAL 7011



DIMENSIONS

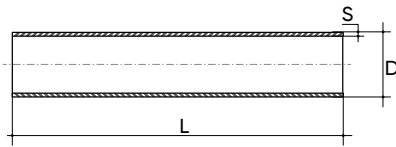

PVC-U PN6 Pressure pipe plain end UNI EN ISO 1452-2

Pressure pipe PVC-U, Grey RAL 7011, length 6m

D (mm)	S (mm)	Weight (kg/m)	PN6 Smooth Code	€	Qty x pallet
40	1,5	0,29	PIPEV2604006L	1,97	275
50	1,6	0,39	PIPEV3305006L	2,65	194
63	2	0,60	PIPEV3306306L	4,07	123
75	2,3	0,83	PIPEV3307506L	5,65	87
90	2,8	1,15	PIPEV3309006L	7,81	96
110	2,7	1,42	PIPEV4111006L	9,32	57
125	3,1	1,86	PIPEV4112506L	12,20	51
140	3,5	2,36	PIPEV4114006L	15,29	45
160	4	3,08	PIPEV4116006L	19,78	33
180	4,4	3,78	PIPEV4118006L	26,14	28
200	4,9	4,66	PIPEV4120006L	30,30	20
225	5,5	5,89	PIPEV4122506L	38,33	18
250	6,2	7,31	PIPEV4125006L	48,09	12
280	6,9	9,12	PIPEV4128006L	63,31	11
315	7,7	11,45	PIPEV4131506L	75,16	9
355	8,7	14,71	PIPEV4135506L	105,38	6
400	9,8	18,45	PIPEV4140006L	126,38	5
500	12,3	28,82	PIPEV4150006L	200,05	2

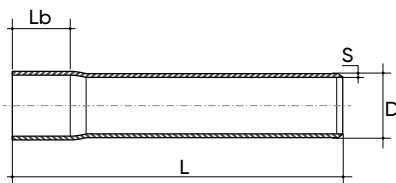

PVC-U PN6 Pressure pipe solvent socket UNI EN ISO 1452-2

Pressure pipe PVC-U, Grey RAL 7011, length 6m

D (mm)	S (mm)	Lb (mm)	Weight (kg/m)	PN6 solvent socket Code	€	Qty x pallet
40	1,5	70	0,29	PIPEV2604016L	1,97	275
50	1,6	85	0,39	PIPEV3305016L	2,65	194
63	2	90	0,60	PIPEV3306316L	4,07	123
75	2,3	105	0,83	PIPEV3307516L	5,65	87
90	2,8	130	1,15	PIPEV3309016L	7,81	96
110	2,7	140	1,42	PIPEV4111016L	9,32	57
125	3,1	150	1,86	PIPEV4112516L	12,20	51
140	3,5	165	2,36	PIPEV4114016L	15,29	45
160	4	175	3,08	PIPEV4116016L	19,78	33
180	4,4	180	3,78	PIPEV4118016L	26,14	28
200	4,9	200	4,66	PIPEV4120016L	30,30	20
225	5,5	215	5,89	PIPEV4122516L	38,33	18
250	6,2	200	7,31	PIPEV4125016L	48,09	12
280	6,9	200	9,12	PIPEV4128016L	63,31	11
315	7,7	240	11,45	PIPEV4131516L	75,16	9
355	8,7	280	14,71	PIPEV4135516L	105,38	6
400	9,8	280	18,45	PIPEV4140016L	126,38	5
500	12,3	350	28,82	PIPEV4150016L	200,05	2

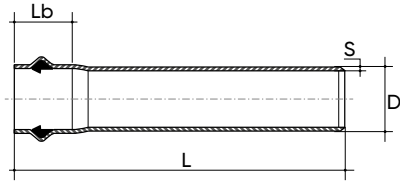

Pressure pipe PVC-U PN6 UNI EN ISO 1452-2 FORSHEDA 601 POWER-LOCK®

Pressure pipe PVC-U, Grey RAL 7011, length 6m

D (mm)	S (mm)	Lb (mm)	Weight (kg/m)	PN6 coupling Code	€	Qty x pallet
40*	1,5	100	0,29	PIPEV26040S6L	1,97	275
50*	1,6	100	0,39	PIPEV26050S6L	2,65	194
63	2	110	0,60	PIPEV33063F6L	4,07	123
75	2,3	120	0,83	PIPEV33075F6L	5,65	87
90	2,8	130	1,15	PIPEV33090F6L	7,81	96
110	2,7	130	1,42	PIPEV41110F6L	9,32	57
125	3,1	150	1,86	PIPEV41125F6L	12,20	51
140	3,5	160	2,36	PIPEV41140F6L	15,29	45
160	4	165	3,08	PIPEV41160F6L	19,78	33
180*	4,4	170	3,78	PIPEV41180S6L	26,14	28
200	4,9	180	4,66	PIPEV41200F6L	30,30	20
225	5,5	200	5,89	PIPEV41225F6L	38,33	18
250	6,2	210	7,31	PIPEV41250F6L	48,09	12
280	6,9	210	9,12	PIPEV41280F6L	63,31	11
315	7,7	230	11,45	PIPEV41315F6L	75,16	9
355	8,7	250	14,71	PIPEV41355F6L	105,38	6
400	9,8	250	18,45	PIPEV41400F6L	126,38	5
500	12,3	255	28,82	PIPEV41500F6L	200,05	2

* Rubber ring

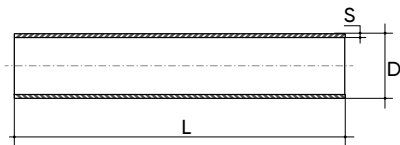

PVC-U PN10 Pressure pipe plain end UNI EN ISO 1452-2

Pressure pipe PVC-U, Grey RAL 7011, length 6m

D (mm)	S (mm)	Weight (kg/m)	PN10 Smooth Code	€	Qty x pallet
32	1,6	0,24	PIPEV2103206L	1,79	449
40	1,9	0,36	PIPEV2104006L	2,41	275
50	2,4	0,56	PIPEV2105006L	3,78	194
63	3	0,89	PIPEV2106306L	5,85	123
75	3,6	1,24	PIPEV2107506L	8,39	87
90	4,3	1,78	PIPEV2109006L	11,00	96
110	4,2	2,15	PIPEV2611006L	13,33	57
125	4,8	2,77	PIPEV2612506L	17,15	51
140	5,4	3,54	PIPEV2614006L	21,63	45
160	6,2	4,61	PIPEV2616006L	28,36	33
180	6,9	5,78	PIPEV2618006L	37,48	28
200	7,7	7,16	PIPEV2620006L	43,85	20
225	8,6	8,99	PIPEV2622506L	55,10	18
250	9,6	11,14	PIPEV2625006L	68,38	12
280	10,7	13,88	PIPEV2628006L	90,62	11
315	12,1	17,61	PIPEV2631506L	109,11	9
355	13,6	22,33	PIPEV2635506L	154,02	6
400	15,3	28,23	PIPEV2640006L	184,83	5
500	19,1	43,91	PIPEV2650006L	290,79	2

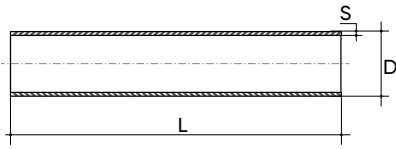

PVC-U PN10 Pressure pipe plain end NF EN 1452

Pressure pipe PVC-U, Grey RAL 7011, length 6m

D (mm)	S (mm)	Weight (kg/m)	PN10 Smooth Code	€	Qty x pallet
63	3	0,89	PIPEV2106306L	5,85	123
75	3,6	1,24	PIPEV2107506L	8,39	87
90	4,3	1,78	PIPEV2109006L	11,00	96
110	5,3	2,67	PIPEV2111006L	13,33	57
125	6	3,41	PIPEV2112506L	17,15	51
140	6,1	3,94	PIPEV2114006L	21,63	45
160	6,2	4,61	PIPEV2616006L	28,36	33
200	7,7	7,16	PIPEU2620006L	43,85	20
225	8,6	8,99	PIPEU2622506L	55,10	18
250	9,6	11,14	PIPEU2625006L	68,38	12
315	12,1	17,61	PIPEU2631506L	109,11	9
400	15,3	28,22	PIPEU2640006L	184,83	5

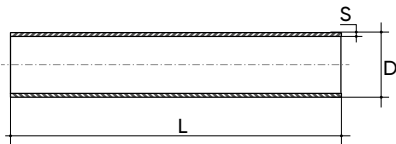

PVC-U PN10 Pressure pipe plain end DIN -8061-62

Pressure pipe PVC-U, Grey RAL 7011, length 6m

D (mm)	S (mm)	Weight (kg/m)	PN10 Smooth Code	€	Qty x pallet
32	1,6	0,24	PIPEV2103206L	1,79	449
40	1,9	0,36	PIPEV2104006L	2,41	275
50	2,4	0,56	PIPEV2105006L	3,78	194
63	3,0	0,89	PIPEV2106306L	5,85	123
75	3,6	1,24	PIPEV2107506L	8,39	87
90	4,3	1,78	PIPEV2109006L	11,00	96
110	5,3	2,67	PIPEV2111006L	16,72	57
125	6,0	3,41	PIPEV2112506L	21,25	51
140	6,7	4,33	PIPEV2114006L	27,07	45
160	7,7	5,67	PIPEV2116006L	35,49	33
180	8,6	7,32	PIPEV2118006L	48,40	28
200	9,6	8,81	PIPEV2120006L	55,23	20
225	10,8	11,13	PIPEV2122506L	69,72	18
250	11,9	13,62	PIPEV2125006L	85,30	12
280	13,4	17,19	PIPEV2128006L	114,06	11
315	15,0	21,59	PIPEV2131506L	134,72	9
355	16,9	27,11	PIPEV2135506L	190,66	6
400	19,1	34,77	PIPEV2140006L	230,66	5

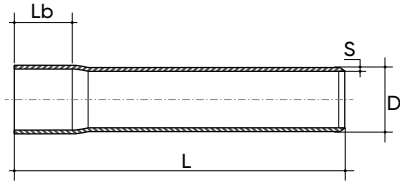

PVC-U PN10 Pressure pipe solvent socket UNI EN ISO 1452-2

Pressure pipe PVC-U, Grey RAL 7011, length 6m

D (mm)	S (mm)	Lb (mm)	Weight (kg/m)	PN10 Coupling Code	€	Qty x pallet
32	1,6	65	0,24	PIPEV2103216L	1,79	449
40	1,9	70	0,36	PIPEV2104016L	2,41	275
50	2,4	85	0,56	PIPEV2105016L	3,78	194
63	3	90	0,89	PIPEV2106316L	5,85	123
75	3,6	105	1,24	PIPEV2107516L	8,39	87
90	4,3	130	1,78	PIPEV2109016L	11,00	96
110	4,2	140	2,15	PIPEV2611016L	13,33	57
125	4,8	150	2,77	PIPEV2612516L	17,15	51
140	5,4	165	3,54	PIPEV2614016L	21,63	45
160	6,2	175	4,61	PIPEV2616016L	28,36	33
180	6,9	180	5,78	PIPEV2618016L	37,48	28
200	7,7	200	7,16	PIPEV2620016L	43,85	20
225	8,6	215	8,99	PIPEV2622516L	55,10	18
250	9,6	200	11,14	PIPEV2625016L	68,38	12
280	10,7	200	13,88	PIPEV2628016L	90,62	11
315	12,1	240	17,61	PIPEV2631516L	109,11	9
355	13,6	280	22,33	PIPEV2635516L	154,02	6
400	15,3	280	28,23	PIPEV2640016L	184,83	5
500	19,1	350	43,91	PIPEV2650016L	290,79	2

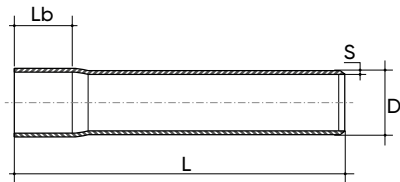

PVC-U PN10 Pressure pipe solvent socket NF EN 1452

Pressure pipe PVC-U, Grey RAL 7011, length 6m

D (mm)	S (mm)	Lb (mm)	Weight (kg/m)	PN10 Coupling Code	€	Qty x pallet
63	3	90	0,89	PIPEV2106316L	5,85	123
75	3,6	105	1,24	PIPEV2107516L	8,39	87
90	4,3	130	1,78	PIPEV2109016L	11,00	96
110	5,3	140	2,67	PIPEV2111016L	13,33	57
125	6	150	3,41	PIPEV2112516L	17,15	51
140	6,1	165	3,94	PIPEV2114016L	21,63	45
160	6,2	175	4,61	PIPEV2616016L	28,36	33
200	7,7	200	7,16	PIPEU2620016L	43,85	20
225	8,6	215	8,99	PIPEU2622516L	55,10	18
250	9,6	200	11,14	PIPEU2625016L	68,38	12
315	12,1	240	17,61	PIPEU2631516L	109,11	9
400	15,3	280	28,22	PIPEU2640016L	184,83	5

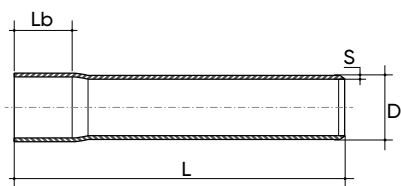

PVC-U PN10 Pressure pipe solvent socket DIN-8061 - 62

Pressure pipe PVC-U, Grey RAL 7011, length 6m

D (mm)	S (mm)	Lb (mm)	Weight (kg/m)	PN10 Coupling Code	€	Qty x pallet
32	1,6	65	0,24	PIPEV2103216L	1,79	449
40	1,9	70	0,36	PIPEV2104016L	2,41	275
50	2,4	85	0,56	PIPEV2105016L	3,78	194
63	3	90	0,89	PIPEV2106316L	5,85	123
75	3,6	105	1,24	PIPEV2107516L	8,39	87
90	4,3	130	1,78	PIPEV2109016L	11,00	96
110	5,3	140	2,67	PIPEV2611016L	16,72	57
125	6	150	3,41	PIPEV2612516L	21,25	51
140	6,7	165	4,33	PIPEV2114016L	27,07	45
160	7,7	175	5,67	PIPEV2116016L	35,49	33
180	8,6	180	7,32	PIPEV2118016L	48,40	28
200	9,6	200	8,81	PIPEV2120016L	55,23	20
225	10,8	215	11,13	PIPEV2122516L	69,72	18
250	11,9	200	13,62	PIPEV2125016L	85,30	12
280	13,4	200	17,19	PIPEV2128016L	114,06	11
315	15	240	21,59	PIPEV2131516L	134,72	9
355	16,9	280	27,11	PIPEV2135516L	190,66	6
400	19,1	280	34,77	PIPEV2140016L	230,66	5

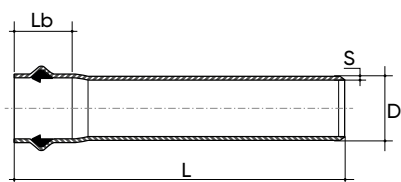

Pressure pipe PVC-U PN10 UNI EN ISO 1452-2 FORSHEDA 601 POWER-LOCK®

Pressure pipe PVC-U, Grey RAL 7011, length 6m

D (mm)	S (mm)	Lb (mm)	Weight (kg/m)	PN10 Forsheeda Code	€	Qty x pallet
40*	1,9	100	0,36	PIPEV21040S6L	2,41	275
50*	2,4	100	0,56	PIPEV21050S6L	3,78	194
63	3	110	0,89	PIPEV21063F6L	5,85	123
75	3,6	120	1,24	PIPEV21075F6L	8,39	87
90	4,3	130	1,78	PIPEV21090F6L	11,00	96
110	4,2	130	2,15	PIPEV26110F6L	13,33	57
125	4,8	150	2,77	PIPEV26125F6L	17,15	51
140	5,4	160	3,54	PIPEV26140F6L	21,63	45
160	6,2	165	4,61	PIPEV26160F6L	28,36	33
180	6,9	170	5,78	PIPEV26180S6L	37,48	28
200	7,7	180	7,16	PIPEV26200F6L	43,85	20
225	8,6	200	8,99	PIPEV26225F6L	55,10	18
250	9,6	210	11,14	PIPEV26250F6L	68,38	12
280	10,7	210	13,88	PIPEV26280F6L	90,62	11
315	12,1	230	17,61	PIPEV26315F6L	109,11	9
355	13,6	250	22,33	PIPEV26355F6L	154,02	6
400	15,3	250	28,23	PIPEV26400F6L	184,83	5
500	19,1	255	43,91	PIPEV26500F6L	290,79	2

* Rubber ring

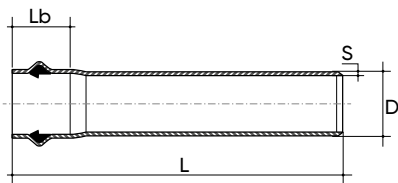

Pressure pipe PVC-U PN10 NF EN 1452 FORSHEDA 601 POWER-LOCK®

Pressure pipe PVC-U, Grey RAL 7011, length 6m

D (mm)	S (mm)	Lb (mm)	Weight (kg/m)	PN10 Forsheeda Code	€	Qty x pallet
63	3	110	0,89	PIPEV21063F6L	5,85	123
75	3,6	120	1,24	PIPEV21075F6L	8,39	87
90	4,3	130	1,78	PIPEV21090F6L	11,00	96
110	5,3	130	2,67	PIPEV21110F6L	13,33	57
125	6	150	3,41	PIPEV21125F6L	17,15	51
140	6,1	160	3,94	PIPEV21140F6L	21,63	45
160	6,2	165	4,61	PIPEV26160F6L	28,36	33
200	7,7	180	7,16	PIPEU26200F6L	43,85	20
225	8,6	200	8,99	PIPEU26225F6L	55,10	18
250	9,6	210	11,14	PIPEU26250F6L	68,38	12
315	12,1	230	17,61	PIPEU26315F6L	109,11	9
400	15,3	250	28,22	PIPEU26400F6L	154,02	5

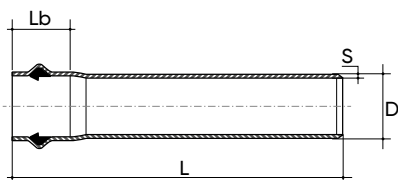

Pressure pipe PVC-U PN10 DIN-8061-62 FORSHEDA 601 POWER-LOCK®

Pressure pipe PVC-U, Grey RAL 7011, length 6m plus solvent socket

D (mm)	S (mm)	Lb (mm)	Weight (kg/m)	PN10 Forsheeda Code	€	Qty x pallet
40*	1,9	100	0,36	PIPEV21040S6L	2,41	275
50*	2,4	100	0,56	PIPEV21050S6L	3,78	194
63	3	110	0,89	PIPEV21063F6L	5,85	123
75	3,6	120	1,24	PIPEV21075F6L	8,39	87
90	4,3	130	1,78	PIPEV21090F6L	11,00	96
110	5,3	130	2,67	PIPEV26110F6L	16,72	57
125	6	150	3,41	PIPEV26125F6L	21,25	51
140	6,7	160	4,33	PIPEV21140F6L	27,07	45
160	7,7	165	5,67	PIPEV21160F6L	35,49	33
180*	8,6	170	7,32	PIPEV21180S6L	48,40	28
200	9,6	180	8,81	PIPEV21200F6L	55,23	20
225	10,8	200	11,13	PIPEV21225F6L	69,72	18
250	11,9	210	13,62	PIPEV21250F6L	85,30	12
280	13,4	210	17,19	PIPEV21280F6L	114,06	11
315	15	230	21,59	PIPEV21315F6L	134,72	9
355	16,9	250	27,11	PIPEV21355F6L	190,66	6
400	19,1	250	34,77	PIPEV21400F6L	230,66	5

* Rubber ring

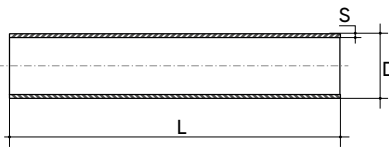

PVC-U PN12.5 Pressure pipe plain end UNI EN ISO 1452-2

Pressure pipe PVC-U, Grey RAL 7011, length 6m

D (mm)	S (mm)	Weight (kg/m)	PN12,5 Smooth Code	€	Qty x pallet
25	1,5	0,18	PIPEV1702506L	1,87	757
32	1,9	0,28	PIPEV1703206L	2,08	449
50	3,0*	0,68	PIPEV1705006L	4,68	194
63	3,8*	1,08	PIPEV1706306L	7,46	123
75	4,5*	1,53	PIPEV1707506L	10,71	87
110	5,3	2,67	PIPEV2111006L	16,72	57
125	6	3,41	PIPEV2112506L	21,25	51
140	6,7	4,33	PIPEV2114006L	27,07	45
160	7,7	5,67	PIPEV2116006L	35,49	33
180	8,6*	7,32	PIPEV2118006L	48,40	28
200	9,6*	8,81	PIPEV2120006L	55,23	20
225	10,8*	11,13	PIPEV2122506L	69,72	18
250	11,9*	13,62	PIPEV2125006L	85,30	12
280	13,4*	17,18	PIPEV2128006L	114,06	11
315	15,0*	21,59	PIPEV2131506L	134,72	9
355	16,9*	27,11	PIPEV2135506L	190,66	6
400	19,1*	34,77	PIPEV2140006L	230,66	5

* Upon request

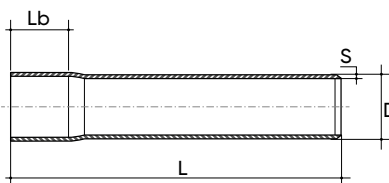

PVC-U PN12.5 Pressure pipe solvent socket UNI EN ISO 1452-2

Pressure pipe PVC-U, Grey RAL 7011, length 6m

D (mm)	LB (mm)	S (mm)	Weight (kg/m)	PN12,5 Coupling Code	€	Qty x pallet
25	40	1,5	0,18	PIPEV1702516L	1,87	757
32	65	1,9	0,28	PIPEV1703216L	2,08	449
50	85	3,0*	0,68	PIPEV1705016L	4,68	194
63	90	3,8*	1,08	PIPEV1706316L	7,46	123
75	105	4,5*	1,53	PIPEV1707516L	10,71	87
110	140	5,3	2,67	PIPEV2111016L	16,72	57
125	150	6	3,41	PIPEV2112516L	21,25	51
140	165	6,7	4,33	PIPEV2114016L	27,07	45
160	175	7,7	5,67	PIPEV2116016L	35,49	33
180	180	8,6*	7,32	PIPEV2118016L	48,40	28
200	200	9,6*	8,81	PIPEV2120016L	55,23	20
225	215	10,8*	11,13	PIPEV2122516L	69,72	18
250	200	11,9*	13,62	PIPEV2125016L	85,30	12
280	200	13,4*	17,18	PIPEV2128016L	114,06	11
315	240	15,0*	21,59	PIPEV2131516L	134,72	9
355	280	16,9*	27,11	PIPEV2135516L	190,66	6
400	280	19,1*	34,77	PIPEV2140016L	230,66	5

* Upon request

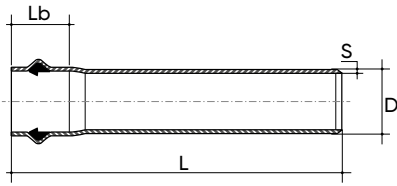

Pressure pipe PVC-U PN12.5 UNI EN ISO 1452-2 FORSHEDA 601 POWER-LOCK®

Pressure pipe PVC-U, Grey RAL 7011, length 6m

D (mm)	LB (mm)	S (mm)	Weight (kg/m)	PN12,5 Coupling Code	€	Qty x pallet
110	130	5,3	2,67	PIPEV21110F6L	16,72	57
125	150	6	3,41	PIPEV21125F6L	21,25	51
140	160	6,7	4,33	PIPEV21140F6L	27,07	45
160	165	7,7	5,67	PIPEV21160F6L	35,49	33
180**	170	8,6*	7,32	PIPEV21180S6L	48,40	28
200	180	9,6*	8,81	PIPEV21200F6L	55,23	20
225	200	10,8*	11,13	PIPEV21225F6L	69,72	18
250	210	11,9*	13,62	PIPEV21250F6L	85,30	12
280	210	13,4*	17,18	PIPEV21280F6L	114,06	11
315	230	15,0*	21,59	PIPEV21315F6L	134,72	9
355	250	16,9*	27,11	PIPEV21355F6L	190,66	6
400	250	19,1*	34,77	PIPEV21400F6L	230,66	5

* Upon request

** Rubber ring

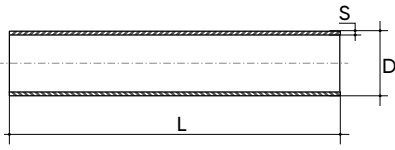

Pressure pipe PVC-U PN16 UNI EN ISO 1452-2

Pressure pipe PVC-U, Grey RAL 7011, length 6m

D (mm)	S (mm)	Weight (kg/m)	PN 16 Smooth Code	€	Qty x pallet
20	1,5	0,14	PIPEV1302006L	1,41	1166
25	1,9	0,22	PIPEV1302506L	2,20	757
32	2,4	0,35	PIPEV1303206L	2,51	449
40	3	0,54	PIPEV1304006L	3,59	275
50	3,7	0,83	PIPEV1305006L	5,54	194
63	4,7	1,31	PIPEV1306306L	8,82	123
75	5,6	1,86	PIPEV1307506L	12,52	87
90	6,7	2,66	PIPEV1309006L	16,42	96
110	6,6	3,26	PIPEV1711006L	20,14	57
125	7,4	4,15	PIPEV1712506L	25,68	51
140	8,3	5,29	PIPEV1714006L	32,24	45
160	9,5	6,89	PIPEV1716006L	42,08	33
180	10,7	8,72	PIPEV1718006L	56,50	28
200	11,9	10,75	PIPEV1720006L	65,79	20
225	13,4	13,63	PIPEV1722506L	83,43	18
250	14,8	16,70	PIPEV1725006L	102,45	12
280	16,6	20,91	PIPEV1728006L	136,76	11
315	18,7	26,49	PIPEV1731506L	163,69	9
355	21,1*	33,31	PIPEV1735506L	232,72	6
400	23,7*	42,44	PIPEV1740006L	278,18	5
500	29,7*	63,6	PIPEV1750006L	432,45	2

* Upon request



Pressure pipe PVC-U PN16 NF-EN 1452

Pressure pipe PVC-U, Grey RAL 7011, length 6m

D (mm)	S (mm)	Weight (kg/m)	PN 16 Smooth Code	€	Qty x pallet
32	2,4	0,35	PIPEV1303206L	2,51	449
40	3	0,54	PIPEV1304006L	3,59	275
50	3,7	0,83	PIPEV1305006L	5,54	194
63	4,7	1,31	PIPEV1306306L	8,82	123
75	5,6	1,86	PIPEV1307506L	12,52	87
90	6,7	2,66	PIPEV1309006L	16,42	96
110	8,1	3,94	PIPEV1311006L	20,14	57
125	9,2	5,07	PIPEV1312506L	25,68	51
140	9,3	5,86	PIPEV1714006L	32,24	45
160	9,5	6,89	PIPEV1716006L	42,08	33
200	11,9	10,75	PIPEV1720006L	65,79	20
225	13,4	13,63	PIPEV1722506L	83,43	18
250	14,8	16,70	PIPEV1725006L	102,45	12
315	18,7	26,49	PIPEV1731506L	163,69	9

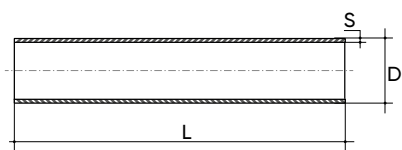

Pressure pipe PVC-U PN16 DIN-8061-62

Pressure pipe PVC-U, Grey RAL 7011, length 6m

D (mm)	S (mm)	Weight (kg/m)	PN 16 Smooth Code	€	Qty x pallet
20	1,5	0,14	PIPEV1302006L	1,41	1166
25	1,9	0,216	PIPEV1302506L	2,20	757
32	2,4	0,35	PIPEV1303206L	2,51	449
40	3	0,54	PIPEV1304006L	3,59	275
50	3,7	0,83	PIPEV1305006L	5,54	194
63	4,7	1,31	PIPEV1306306L	8,82	123
75	5,6	1,86	PIPEV1307506L	12,52	87
90	6,7	2,66	PIPEV1309006L	16,42	96
110	8,1	3,94	PIPEV1311006L	24,61	57
125	9,2	5,07	PIPEV1312506L	31,69	51
140	10,3	6,43	PIPEV1314006L	39,71	45
160	11,8	8,40	PIPEV1316006L	51,85	33
200	14,7	13,06	PIPEV1320006L	80,83	20
225	16,6	16,53	PIPEV1322506L	102,38	18
250	18,4	20,37	PIPEV1325006L	124,43	12

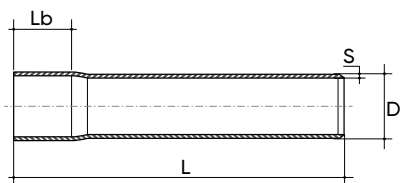

PVC-U PN16 Pressure pipe solvent socket UNI EN ISO 1452-2

Pressure pipe PVC-U, Grey RAL 7011, length 6m

D (mm)	Lb (mm)	S (mm)	Weight (kg/m)	PN 16 Coupling Code	€	Qty x pallet
20	37	1,5	0,14	PIPEV1302016L	1,41	1166
25	40	1,9	0,22	PIPEV1302516L	2,20	757
32	65	2,4	0,35	PIPEV1303216L	2,51	449
40	70	3	0,54	PIPEV1304016L	3,59	275
50	85	3,7	0,83	PIPEV1305016L	5,54	194
63	90	4,7	1,31	PIPEV1306316L	8,82	123
75	105	5,6	1,86	PIPEV1307516L	12,52	87
90	130	6,7	2,66	PIPEV1309016L	16,42	96
110	140	6,6	3,26	PIPEV1711016L	20,14	57
125	150	7,4	4,15	PIPEV1712516L	25,68	51
140	165	8,3	5,29	PIPEV1714016L	32,24	45
160	175	9,5	6,89	PIPEV1716016L	42,08	33
180	180	10,7	8,72	PIPEV1718016L	56,50	28
200	200	11,9	10,75	PIPEV1720016L	65,79	20
225	215	13,4	13,63	PIPEV1722516L	83,43	18
250	200	14,8	16,70	PIPEV1725016L	102,45	12
280	200	16,6	20,91	PIPEV1728016L	136,76	11
315	240	18,7	26,49	PIPEV1731516L	163,69	9
355	280	21,1*	33,31	PIPEV1735516L	232,72	6
400	280	23,7*	42,44	PIPEV1740016L	278,18	5
500	350	29,7*	63,6	PIPEV1750016L	432,45	2

* Upon request

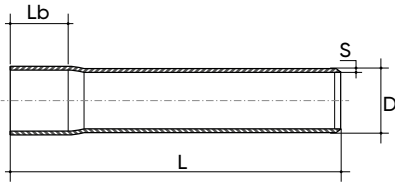

PVC-U PN16 Pressure pipe solvent socket NF.EN 1452

Pressure pipe PVC-U, Grey RAL 7011, length 6m

D (mm)	Lb (mm)	S (mm)	Weight (kg/m)	PN 16 Coupling Code	€	Qty x pallet
32	65	2,4	0,35	PIPEV1303216L	2,51	449
40	70	3	0,54	PIPEV1304016L	3,59	275
50	85	3,7	0,83	PIPEV1305016L	5,54	194
63	90	4,7	1,31	PIPEV1306316L	8,82	123
75	105	5,6	1,86	PIPEV1307516L	12,52	87
90	130	6,7	2,66	PIPEV1309016L	16,42	96
110	140	8,1	3,94	PIPEV1311016L	24,61	57
125	150	9,2	5,07	PIPEV1312516L	31,69	51
140	165	9,3	5,86	PIPEV1714016L	36,60	45
160	175	9,5	6,89	PIPEV1716016L	42,08	33
200	200	11,9	10,75	PIPEV1720016L	65,79	20
225	215	13,4	13,63	PIPEV1722516L	83,43	18
250	200	14,8	16,70	PIPEV1725016L	102,45	12
315	240	18,7	26,49	PIPEV1731516L	163,69	9

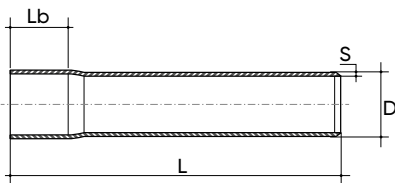

PVC-U PN16 Pressure pipe solvent socket DIN-8061-62

Pressure pipe PVC-U, Grey RAL 7011, length 6m

D (mm)	Lb (mm)	S (mm)	Weight (kg/m)	PN 16 Coupling Code	€	Qty x pallet
20	37	1,5	0,14	PIPEV1302016L	1,41	1166
25	40	1,9	0,216	PIPEV1302516L	2,20	757
32	65	2,4	0,35	PIPEV1303216L	2,51	449
40	70	3	0,54	PIPEV1304016L	3,59	275
50	85	3,7	0,83	PIPEV1305016L	5,54	194
63	90	4,7	1,31	PIPEV1306316L	8,82	123
75	105	5,6	1,86	PIPEV1307516L	12,52	87
90	130	6,7	2,66	PIPEV1309016L	16,42	96
110	140	8,1	3,94	PIPEV1311016L	24,61	57
125	150	9,2	5,07	PIPEV1312516L	31,69	51
140	165	10,3	6,43	PIPEV1314016L	39,71	45
160	175	11,8	8,40	PIPEV1316016L	51,85	33
200	200	14,7	13,06	PIPEV1320016L	80,83	20
225	215	16,6	16,53	PIPEV1322516L	102,38	18
250	200	18,4	20,37	PIPEV1325016L	124,43	12

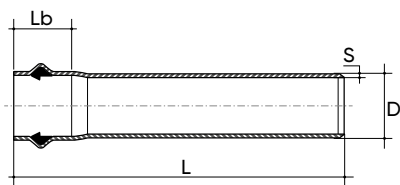

Pressure pipe PVC-U PN16 UNI EN ISO 1452-2 FORSHEDA 601 POWER-LOCK®

Pressure pipe PVC-U, Grey RAL 7011, length 6m

D (mm)	Lb (mm)	S (mm)	Weight (kg/m)	PN 16 Coupling Code	€	Qty x pallet
40**	100	3	0,54	PIPEV13040S6L	3,59	275
50**	100	3,7	0,83	PIPEV13050S6L	5,54	194
63	110	4,7	1,31	PIPEV13063F6L	8,82	123
75	120	5,6	1,86	PIPEV13075F6L	12,52	87
90	130	6,7	2,66	PIPEV13090F6L	16,42	96
110	130	6,6	3,26	PIPEV17110F6L	20,14	57
125	150	7,4	4,15	PIPEV17125F6L	25,68	51
140	160	8,3	5,29	PIPEV17140F6L	32,24	45
160	165	9,5	6,89	PIPEV17160F6L	42,08	33
180**	170	10,7	8,72	PIPEV17180S6L	56,50	28
200	180	11,9	10,75	PIPEV17200F6L	65,79	20
225	200	13,4	13,63	PIPEV17225F6L	83,43	18
250	210	14,8	16,70	PIPEV17250F6L	102,45	12
280	210	16,6	20,91	PIPEV17280F6L	136,76	11
315	230	18,7	26,49	PIPEV17315F6L	163,69	9
355	250	21,1*	33,31	PIPEV17355F6L	232,72	6
400	250	23,7*	42,44	PIPEV17400F6L	278,18	5
500	255	29,7*	63,6	PIPEV17500F6L	432,45	2

* Upon request

** Rubber ring

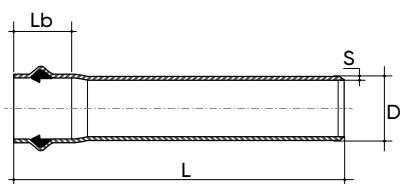

Pressure pipe PVC-U PN16 NF-EN 1452 FORSHEDA 601 POWER-LOCK®

Pressure pipe PVC-U, Grey RAL 7011, length 6m

D (mm)	Lb (mm)	S (mm)	Weight (kg/m)	PN 16 Coupling Code	€	Qty x pallet
40*	100	3	0,54	PIPEV13040S6L	3,59	275
50*	100	3,7	0,83	PIPEV13050S6L	5,54	194
63	110	4,7	1,31	PIPEV13063F6L	8,82	123
75	120	5,6	1,86	PIPEV13075F6L	12,52	87
90	130	6,7	2,66	PIPEV13090F6L	16,42	96
110	130	8,1	3,94	PIPEV13110F6L	24,61	57
125	150	9,2	5,07	PIPEV13125F6L	31,69	51
140	160	9,3	5,86	PIPEV17140F6L	36,60	45
160	165	9,5	6,89	PIPEV17160F6L	42,08	33
200	180	11,9	10,75	PIPEV17200F6L	65,79	20
225	200	13,4	13,63	PIPEV17225F6L	83,43	18
250	210	14,8	16,70	PIPEV17250F6L	102,45	12
315	230	18,7	26,49	PIPEV17315F6L	163,69	9

* Rubber ring

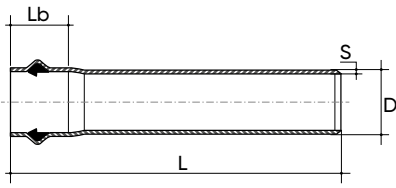

Pressure pipe PVC-U PN16 DIN-8061-2 FORSHEDA 601 POWER-LOCK®

Pressure pipe PVC-U, Grey RAL 7011, length 6m plus solvent socket

D (mm)	Lb (mm)	S (mm)	Weight (kg/m)	PN 16 Coupling Code	€	Qty x pallet
40*	100	3	0,54	PIPEV13040S6L	3,59	275
50*	100	3,7	0,83	PIPEV13050S6L	5,54	194
63	110	4,7	1,31	PIPEV13063F6L	8,82	123
75	120	5,6	1,86	PIPEV13075F6L	12,52	87
90	130	6,7	2,66	PIPEV13090F6L	16,42	96
110	130	8,1	3,94	PIPEV13110F6L	24,61	57
125	150	9,2	5,07	PIPEV13125F6L	31,69	51
140	160	10,3	6,43	PIPEV13140F6L	39,71	45
160	165	11,8	8,40	PIPEV13160F6L	51,85	33
200	180	14,7	13,06	PIPEV13200F6L	80,83	20
225	200	16,6	16,53	PIPEV13225F6L	102,38	18
250	210	18,4	20,37	PIPEV13250F6L	124,43	12

* Rubber ring

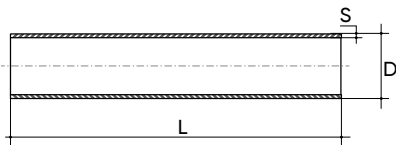

Pressure pipe PVC-U PN20 UNI EN ISO 1452-2

Pressure pipe PVC-U, Grey RAL 7011, length 6m

D (mm)	S (mm)	Weight (kg/m)	PN 20 Smooth Code	€	Qty x pallet
16	1,5	0,109	PIPEV1101606L	1,18	Sfuso
20	1,9*	0,169	PIPEV1102006L	1,74	1166
25	2,3*	0,26	PIPEV1102506L	2,65	757
32	2,9*	0,41	PIPEV1103206L	2,96	449
40	3,7*	0,65	PIPEV1104006L	4,33	275
50	4,6*	1,00	PIPEV1105006L	6,78	194
63	5,8*	1,58	PIPEV1106306L	10,73	123
75	6,8*	2,21	PIPEV1107506L	15,04	87
90	8,2*	3,19	PIPEV1109006L	19,70	96
110	8,1*	3,94	PIPEV1311006L	24,61	57
125	9,2*	5,07	PIPEV1312506L	31,69	51
140	10,3*	6,43	PIPEV1314006L	39,71	45
160	11,8*	8,40	PIPEV1316006L	51,85	33
200	14,7*	13,06	PIPEV1320006L	80,83	20
225	16,6*	16,53	PIPEV1322506L	102,38	18
250	18,4*	20,37	PIPEV1325006L	124,43	12

* Upon request

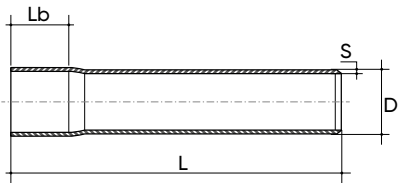

PVC-U PN20 Pressure pipe solvent socket UNI EN ISO 1452-2

Pressure pipe PVC-U, Grey RAL 7011, length 6m

D (mm)	S (mm)	Lb (mm)	Weight (kg/m)	PN 20 Coupling Code	€	Qty x pallet
16	1,5		0,109	PIPEV1101616L	1,18	Sfuso
20	1,9*	37	0,169	PIPEV1102016L	1,74	1166
25	2,3*	40	0,26	PIPEV1102516L	2,65	757
32	2,9*	65	0,41	PIPEV1103216L	2,96	449
40	3,7*	70	0,65	PIPEV1104016L	4,33	275
50	4,6*	85	1,00	PIPEV1105016L	6,78	194
63	5,8*	90	1,58	PIPEV1106316L	10,73	123
75	6,8*	105	2,21	PIPEV1107516L	15,04	87
90	8,2*	130	3,19	PIPEV1109016L	19,70	96
110	8,1*	140	3,94	PIPEV1311016L	24,61	57
125	9,2*	150	5,07	PIPEV1312516L	31,69	51
140	10,3*	165	6,43	PIPEV1314016L	39,71	45
160	11,8*	175	8,40	PIPEV1316016L	51,85	33
200	14,7*	200	13,06	PIPEV1320016L	80,83	20
225	16,6*	215	16,53	PIPEV1322516L	102,38	18
250	18,4*	200	20,37	PIPEV1325016L	124,43	12

* Upon request

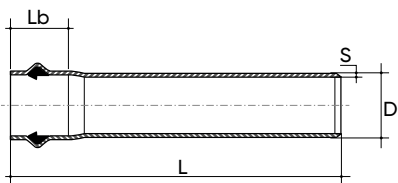

Pressure pipe PVC-U PN20 UNI EN ISO 1452-2 FORSHEDA 601 POWER-LOCK®

Pressure pipe PVC-U, Grey RAL 7011, length 6m

D (mm)	S (mm)	Lb (mm)	Weight (kg/m)	PN 20 Coupling Code	€	Qty x pallet
40**	3,7*	100	0,65	PIPEV11040S6L	4,33	275
50**	4,6*	100	1,00	PIPEV11050S6L	6,78	194
63	5,8*	110	1,58	PIPEV11063F6L	10,73	123
75	6,8*	120	2,21	PIPEV11075F6L	15,04	87
90	8,2*	130	3,19	PIPEV11090F6L	19,70	96
110	8,1*	130	3,94	PIPEV13110F6L	24,61	57
125	9,2*	150	5,07	PIPEV13125F6L	31,69	51
140	10,3*	160	6,43	PIPEV13140F6L	39,71	45
160	11,8*	165	8,40	PIPEV13160F6L	51,85	33
200	14,7*	180	13,06	PIPEV13200F6L	80,83	20
225	16,6*	200	16,53	PIPEV13225F6L	102,38	18
250	18,4*	210	20,37	PIPEV13250F6L	124,43	12

* Upon request

** Rubber ring

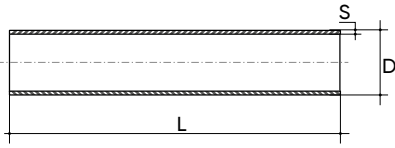

Pressure pipe PVC-U PN25 NF-EN 1452-2

Pressure pipe PVC-U, Grey RAL 7011, length 6m

D (mm)	S (mm)	Weight (kg/m)	PN 25 Smooth Code	€	Qty x pallet
16	1,8	0,13	PIPEV0901606L	1,39	Sfuso
20	2,3	0,2	PIPEV0902006L	2,10	1166
25	2,8	0,30	PIPEV0902506L	3,17	757
32	3,6	0,49	PIPEV0903206L	3,67	449
40	4,5	0,77	PIPEV0904006L	5,71	275
50	5,6*	1,19	PIPEV0905006L	8,86	194
63	7,1*	1,89	PIPEV0906306L	14,12	123

* Upon request

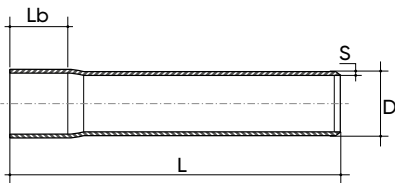

PVC-U PN25 Pressure pipe solvent socket NF-EN 1452-2

Pressure pipe PVC-U, Grey RAL 7011, length 6m

D (mm)	S (mm)	Lb (mm)	Weight (kg/m)	PN 25 Coupling Code	€	Qty x pallet
16	1,8		0,13	PIPEV0901616L	1,39	Sfuso
20	2,3	37	0,2	PIPEV0902016L	2,10	1166
25	2,8	40	0,30	PIPEV0902516L	3,17	757
32	3,6	65	0,49	PIPEV0903216L	3,67	449
40	4,5	70	0,77	PIPEV0904016L	5,71	275
50	5,6*	85	1,19	PIPEV0905016L	8,86	194
63	7,1*	90	1,89	PIPEV0906316L	14,12	123

* Upon request

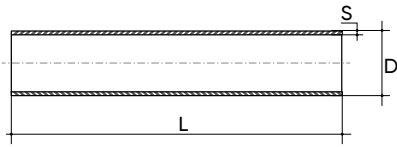

Pressure pipe PVC-U PN9/CLASS C BS-EN 1452, BS 3505

Pressure pipe PVC-U, Grey RAL 7011, length 6m

D (inches)	S (mm)	Weight (kg/m)	PN9 CLASS C Code	€	Qty x pallet
2"	2,5	0,73	PIPEVBSC20006L	6,26	252
2" 1/2	3	1,22	PIPEVBSC21206L	10,69	87
3"	3,5	1,48	PIPEVBSC30006L	12,53	96
4"	4,5	2,42	PIPEVBSC40006L	20,80	67
5"	5,5	3,63	PIPEVBSC50006L	31,26	45
6"	6,6	5,20	PIPEVBSC60006L	44,65	30
8"	7,8	8,05	PIPEVBSC80006L	69,14	18

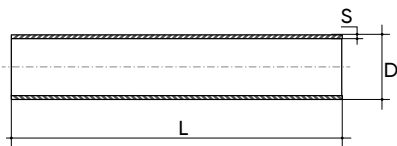

Pressure pipe PVC-U PN12/CLASS D BS-EN 1452, BS 3505

Pressure pipe PVC-U, Grey RAL 7011, length 6m

D (inches)	S (mm)	Weight (kg/m)	PN12 CLASS D Code	€	Qty x pallet
1" 1/4	2,2	0,44	PIPEVBSD11406L	3,76	292
1" 1/2	2,5	0,58	PIPEVBSD11206L	4,93	207
2"	3,1	0,88	PIPEVBSD20006L	7,52	252
3"	4,6	1,90	PIPEVBSD30006L	16,01	96
4"	6	3,17	PIPEVBSD40006L	27,22	67
6"	8,8	6,81	PIPEVBSD60006L	58,47	30
8"	10,3	10,36	PIPEVBSD80006L	89,03	18

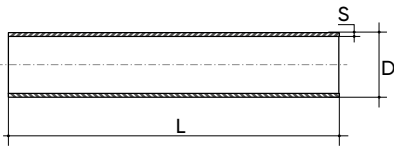

PVC-U pressure pipe PN15/CLASS E BS-EN 1452, BS 3505

Pressure pipe PVC-U, Grey RAL 7011, length 6m

D (inches)	S (mm)	Weight (kg/m)	PN15 CLASS E Code	€	Qty x pallet
3/8"	1,5	0,116	PIPEVBSE03806L	1,15	Sfuso
1/2"	1,7	0,17	PIPEVBSE01206L	1,53	1103
3/4"	1,9	0,24	PIPEVBSE03406L	2,12	664
1"	2,2	0,34	PIPEVBSE10006L	2,98	436
1" 1/4	2,7	0,54	PIPEVBSE11406L	4,62	292
1" 1/2	3,1	0,70	PIPEVBSE11206L	5,96	207
2"	3,9	1,08	PIPEVBSE20006L	9,22	252
2" 1/2	4,8	1,82	PIPEVBSE21206L	15,42	87
3"	5,7	2,32	PIPEVBSE30006L	19,61	96
4"	7,3	3,79	PIPEVBSE40006L	33,37	67
6"	10,8	8,20	PIPEVBSE60006L	70,48	30

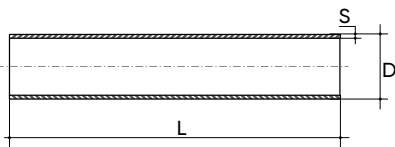

Pressure pipe PVC-U CLASS 7 BS-EN 1452, BS 3505

Pressure pipe PVC-U, Grey RAL 7011, length 6m

D (inches)	S (mm)	Weight (kg/m)	CLASS 7 Code	€	Qty x pallet
1/2"	3,7	0,32	PIPEVBS701206L	2,89	1103
3/4"	3,9	0,433	PIPEVBS703406L	3,91	664
1"	4,5	0,64	PIPEVBS710006L	5,96	436
1" 1/4	4,8	0,87	PIPEVBS711406L	7,73	292
1" 1/2	5,1	1,08	PIPEVBS701206L	9,22	207
2"	5,5	1,48	PIPEVBS720006L	12,57	252

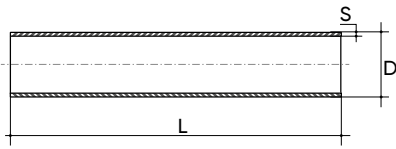

PN10 Threadable PVC-U Pressure pipe

Pressure pipe PVC-U, Grey RAL 7011, length 5m

D (inches)	Øe (mm)	S (mm)	Weight (kg/m)	PN10 Code	€	Qty x pallet
1/2"	21,2	2,6	0,232	PIPEVT10012TOL	2,12	1103
3/4"	26,6	2,6	0,3	PIPEVT10034TOL	2,70	664
1"	33,4	3,3	0,481	PIPEVT10100TOL	4,17	436
1" 1/4	42,1	3,7	0,686	PIPEVT10114TOL	5,96	292
1" 1/2	48,1	4	0,852	PIPEVT10112TOL	7,30	207
2"	60,2	4,6	1,238	PIPEVT10200TOL	10,41	252
2" 1/2	75	5,3	1,795	PIPEVT10212TOL	15,77	87
3"	88,7	6	2,386	PIPEVT10300TOL	20,22	96
4"	114,1	7	3,809	PIPEVT10400TOL	32,70	67

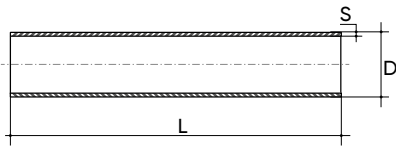

PN16 Threadable PVC-U Pressure pipe

Pressure pipe PVC-U, Grey RAL 7011, length 5m

D (inches)	Øe (mm)	S (mm)	Weight (kg/m)	PN16 Code	€	Qty x pallet
3/8"	17,1	2,6	0,179	PIPEVT16038TOL	1,77	Sfuso
1/2"	21,2	3	0,26	PIPEVT16012TOL	2,40	1103
3/4"	26,6	3,4	0,38	PIPEVT16034TOL	3,41	664
1"	33,4	4,3	0,6	PIPEVT16100TOL	5,66	436
1" 1/4	42,1	5	0,894	PIPEVT16114TOL	7,73	292
1" 1/2	48,1	5,4	1,278	PIPEVT16112TOL	9,83	207
2"	60,2	6,4	1,648	PIPEVT16200TOL	14,02	252

PVC-U pipe

TRANSPARENT



TRANSPARENT PVC-U PIPES

Pressure pipes for joint system by cold chemical welding (gluing through the use of suitable WELDON adhesive and detergent primer) in transparent rigid PVC that offers good impact resistance and high light permeability. Ideal economic solution for visible applications.

Technical specifications	
Size range	d 20 - d 160 (mm)
Bar length	Standard 5.0 m bars, other sizes on request
Coupling standards	Solvent welding
Sectors of use	Pool circulation and filtration systems Inspection points on small plants
Pipe material	PVC-U transparent



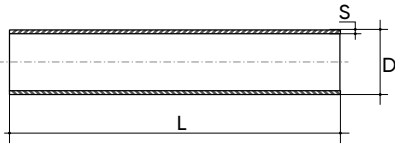

Transparent PVC-U pipe

PVC-U Pressure pipe, transparent, length 5m

D (inches)	S (mm)	SDR	Weight (kg/m)	Code	€
20	1.5	13	0.13	PIPET13020	4,84
25	1.9	13	0.21	PIPET13025	6,54
32	2.4	13	0.34	PIPET13032	9,30
40	3	13	0.51	PIPET13040	14,00
50	2.4	21	0.54	PIPET21050	14,09
63	3	21	0.84	PIPET21063	22,16
75	3.6	21	1.19	PIPET21075	36,44
90	4.3	21	1.71	PIPET21090	52,24
110	5.3	21	2.56	PIPET21110	76,98
140	2.8	51	1.80	PIPET51140	69,59
160	3.2	51	2.36	PIPET51160	75,61

PVC-U thermoformed fittings

PUSH-FIT, GLUABLE, FLANGED JOINTS



DIMENSIONS

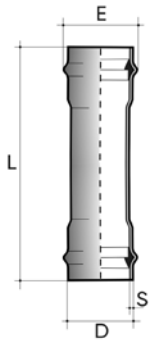

Sliding sleeve PN10 (MANIC)

PVC-U Sleeve, Grey RAL 7011, Rubber ring connection, FORSHEDA 601 POWER-LOCK® on request

D (mm)	E (mm)	L (mm)	Weight (gr)	PN10 Code	€
50	72,4	295	170	MANVPN1005OSSL	15,77
63	89	285	360	MANVPN10063SSL	19,04
75	103,5	280	540	MANVPN10075SSL	21,80
90	121	295	820	MANVPN1009OSSL	24,01
110	143	317	720	MANVPN1011OSSL	25,44
125	160	320	1.310	MANVPN10125SSL	33,87
140	180	346	1.870	MANVPN1014OSSL	49,93
160	207	350	1.690	MANVPN1016OSSL	51,07
180	224	390	3.340	MANVPN1018OSSL	64,01
200	248	418	4.320	MANVPN1020OSSL	74,93
225	276	435	5.810	MANVPN10225SSL	95,73
250	306	505	8.170	MANVPN1025OSSL	126,24
280	338	494	7.010	MANVPN1028OSSL	161,68
315	378	494	13.350	MANVPN10315SSL	231,10
355	441	635	22.680	MANVPN10355SSL	438,53
400	482	642	27.550	MANVPN1040OSSL	527,39

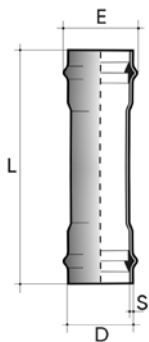

Sliding sleeve PN16 (MANIC)

PVC-U Sleeve, Grey RAL 7011, Rubber ring connection, FORSHEDA 601 POWER-LOCK® on request

D (mm)	E (mm)	L (mm)	Weight (gr)	PN16 Code	€
50	72,4	295	180	MANVPN1605OSSL	18,53
63	89	285	380	MANVPN16063SSL	19,51
75	103,5	280	570	MANVPN16075SSL	22,17
90	121	295	870	MANVPN1609OSSL	25,16
110	143	317	1.080	MANVPN1611OSSL	40,61
125	160	320	1.380	MANVPN16125SSL	44,33
140	180	346	1.970	MANVPN1614OSSL	53,91
160	207	350	2.530	MANVPN1616OSSL	69,43
180	224	390	3.510	MANVPN1618OSSL	77,61
200	248	418	4.550	MANVPN1620OSSL	92,23
225	276	435	6.120	MANVPN16225SSL	129,21
250	306	505	8.600	MANVPN1625OSSL	159,88
280	338	494	7.380	MANVPN1628OSSL	195,67
315	378	494	14.050	MANVPN16315SSL	273,93
355	441	635	23.870	MANVPN16355SSL	504,78
400	482	642	29.000	MANVPN1640OSSL	591,97

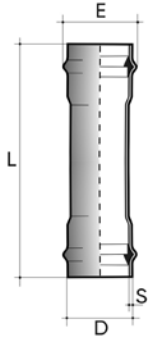

Sliding sleeve (long) PN10 (MARIP)

PVC-U Sleeve, Grey RAL 7011, Rubber ring connection, FORSHEDA 601 POWER-LOCK® on request

D (mm)	E (mm)	L (mm)	Weight (gr)	PN10 Code	€
63	90	494	640	MARVPN10063SSL	21,75
75	104,7	488	900	MARVPN10075SSL	24,31
90	121,5	515	1.380	MARVPN10090SSL	29,88
110	143	543	1.770	MARVPN10110SSL	36,81
125	160	537	2.190	MARVPN10125SSL	44,30
140	180	545	2.890	MARVPN10140SSL	64,89
160	196,5	600	2.890	MARVPN10160SSL	72,09
180	224	590	5.010	MARVPN10180SSL	98,87
200	247	645	6.510	MARVPN10200SSL	119,81
225	276	645	8.710	MARVPN10225SSL	166,71
250	306	670	10.760	MARVPN10250SSL	241,90
280	338	640	14.400	MARVPN10280SSL	286,35
315	378	640	15.800	MARVPN10315SSL	360,24
355	441	635	22.680	MARVPN10355SSL	438,53
400	482	642	27.550	MARVPN10400SSL	527,39

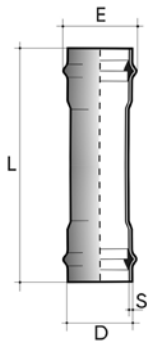

Sliding sleeve (long) PN16 (MARIP)

PVC-U Sleeve, Grey RAL 7011, Rubber ring connection, FORSHEDA 601 POWER-LOCK® on request

D (mm)	E (mm)	L (mm)	Weight (gr)	PN16 Code	€
63	90	494	670	MARVPN16063SSL	26,87
75	104,7	488	950	MARVPN16075SSL	29,48
90	121,5	515	1.450	MARVPN16090SSL	35,93
110	143	543	1.860	MARVPN16110SSL	49,56
125	160	537	2.310	MARVPN16125SSL	53,23
140	180	545	3.050	MARVPN16140SSL	84,94
160	196,5	600	4.320	MARVPN16160SSL	122,36
180	224	590	5.270	MARVPN16180SSL	133,48
200	247	645	6.850	MARVPN16200SSL	143,71
225	276	645	9.170	MARVPN16225SSL	200,57
250	306	670	11.330	MARVPN16250SSL	294,67
280	338	640	13.700	MARVPN16280SSL	355,92
315	378	640	17.300	MARVPN16315SSL	415,21
355	441	635	23.870	MARVPN16355SSL	504,78
400	482	642	29.000	MARVPN16400SSL	591,97

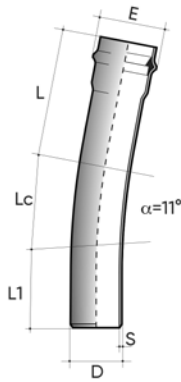

POWER-LOCK bend 11° M/F PN16 (BEND)

Bend PVC-U, M/F, Grey RAL 7011, FORSHEDA 601 POWER-LOCK® connection

D (mm)	E (mm)	L (mm)	Lc (mm)	L1 (mm)	Weight (gr)	PN10 Code	€
63	86	350	280	275	790	PBVPN10063F1L	32,52
75	102	280	280	355	1.120	PBVPN10075F1L	34,15
90	120	320	340	300	1.740	PBVPN10090F1L	37,57
110	144	315	295	300	1.930	PBVPN10110F1L	42,49
125	161	350	340	285	2.690	PBVPN10125F1L	51,11
140	178	330	375	315	3.610	PBVPN10140F1L	64,35
160	202	330	435	345	5.030	PBVPN10160F1L	87,71
180*	224	420	280	400	7.070	PBVPN10180S1L	181,77
200	238	430	280	390	10.950	PBVPN10200F1L	211,75
225	276	470	310	320	12.840	PBVPN10225F1L	274,33
250	305	520	310	380	15.900	PBVPN10250F1L	389,78
280	341	480	340	480	21.240	PBVPN10280F1L	487,62
315	382	480	370	450	26.950	PBVPN10315F1L	590,11

*Rubber ring

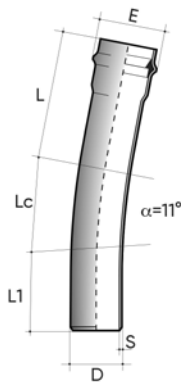

Curva POWER-LOCK 11° M/F PN16 (BEND)

Curva PVC-U, M/F, Grigio RAL 7011, connessione FORSHEDA 601 POWER-LOCK®

D (mm)	E (mm)	L (mm)	Lc (mm)	L1 (mm)	Weight (gr)	PN16 Code	€
63	86	350	280	275	1.180	PBVPN16063F1L	45,43
75	102	280	280	355	1.690	PBVPN16075F1L	56,22
90	120	320	340	300	2.630	PBVPN16090F1L	62,93
110	144	315	295	300	2.930	PBVPN16110F1L	65,23
125	161	350	340	285	4.110	PBVPN16125F1L	74,02
140	178	330	375	315	5.610	PBVPN16140F1L	92,94
160	202	330	435	345	7.800	PBVPN16160F1L	117,56
180*	224	420	280	400	10.670	PBVPN16180S1L	282,64
200	238	430	280	390	13.710	PBVPN16200F1L	307,81
225	276	470	310	320	20.160	PBVPN16225F1L	383,19
250	305	520	310	380	24.700	PBVPN16250F1L	527,99
280	341	480	340	480	33.070	PBVPN16280F1L	745,37
315	382	480	370	450	41.880	PBVPN16315F1L	869,62
400	465	610	450	640	85.590	PBVPN16400F1L	2.955,56

*Rubber ring

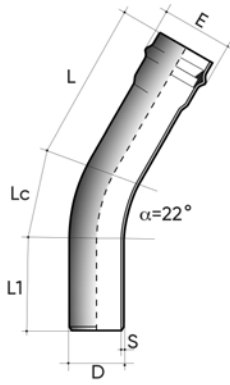

POWER-LOCK bend 11° M/F PN16 (BEND)

Bend PVC-U, M/F, Grey RAL 7011, FORSHEDA 601 POWER-LOCK® connection

D (mm)	E (mm)	L (mm)	Lc (mm)	L1 (mm)	Weight (gr)	PN10 Code	€
63	86	350	280	270	790	PBVPN10063F2L	32,52
75	102	280	280	355	1.120	PBVPN10075F2L	34,15
90	120	320	340	300	1.740	PBVPN10090F2L	37,57
110	144	315	295	300	1.930	PBVPN10110F2L	42,49
125	161	350	340	285	2.690	PBVPN10125F2L	51,11
140	178	330	375	315	3.610	PBVPN10140F2L	64,35
160	202	330	435	345	5.030	PBVPN10160F2L	87,71
180*	224	460	330	410	7.070	PBVPN10180S2L	181,77
200	238	470	330	400	10.950	PBVPN10200F2L	211,75
225	276	490	510	420	12.840	PBVPN10225F2L	274,33
250	305	510	520	370	15.900	PBVPN10250F2L	389,78
280	341	480	590	430	21.240	PBVPN10280F2L	487,62
315	382	540	510	450	26.950	PBVPN10315F2L	590,11
400	465	610	880	510	57.580	PBVPN10400F2L	1.102,54

*Rubber ring

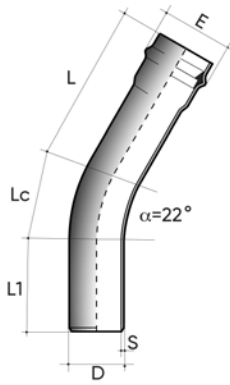

POWER-LOCK bend 22° M/F PN16 (BEND)

Bend PVC-U, M/F, Grey RAL 7011, FORSHEDA 601 POWER-LOCK® connection

D (mm)	E (mm)	L (mm)	Lc (mm)	L1 (mm)	Weight (gr)	PN16 Code	€
63	86	350	280	270	1.180	PBVPN16063F2L	45,43
75	102	280	280	355	1.690	PBVPN16075F2L	56,22
90	120	320	340	300	2.630	PBVPN16090F2L	62,93
110	144	315	295	300	2.930	PBVPN16110F2L	65,23
125	161	350	340	285	4.110	PBVPN16125F2L	74,02
140	178	330	375	315	5.610	PBVPN16140F2L	92,94
160	202	330	435	345	7.800	PBVPN16160F2L	117,56
180*	224	460	330	410	10.670	PBVPN16180S2L	282,64
200	238	470	330	400	13.710	PBVPN16200F2L	307,81
225	276	490	510	420	20.160	PBVPN16225F2L	383,19
250	305	510	520	370	24.700	PBVPN16250F2L	527,99
280	341	480	590	430	33.070	PBVPN16280F2L	745,37
315	382	540	510	450	41.880	PBVPN16315F2L	869,62
400	465	610	880	510	85.590	PBVPN16400F2L	2.955,56

*Rubber ring

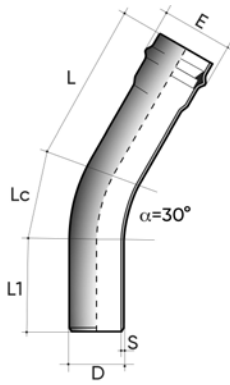

POWER-LOCK bend 30° M/F PN10 (BEND)

Bend PVC-U, M/F, Grey RAL 7011, FORSHEDA 601 POWER-LOCK® connection

D (mm)	E (mm)	L (mm)	Lc (mm)	L1 (mm)	Weight (gr)	PN10 Code	€
63	86	350	280	275	790	PBVPN10063F3L	32,52
75	102	280	280	355	1.120	PBVPN10075F3L	34,15
90	120	320	340	300	1.740	PBVPN10090F3L	37,57
110	144	315	295	300	1.930	PBVPN10110F3L	42,49
125	161	350	340	285	2.690	PBVPN10125F3L	51,11
140	178	330	375	315	3.610	PBVPN10140F3L	64,35
160	202	330	435	345	5.030	PBVPN10160F3L	87,71
180*	224	460	680	310	7.070	PBVPN10180S3L	181,77
200	238	475	680	295	10.950	PBVPN10200F3L	211,75
225	276	490	840	270	12.840	PBVPN10225F3L	274,33
250	305	490	840	370	15.900	PBVPN10250F3L	389,78
280	341	480	870	350	21.240	PBVPN10280F3L	487,62
315	382	590	870	390	26.950	PBVPN10315F3L	590,11
400	465	710	1070	720	57.580	PBVPN10400F3L	1.102,54

*Rubber ring

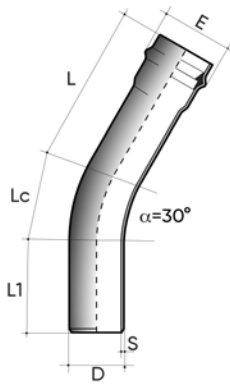

POWER-LOCK bend 30° M/F PN16 (BEND)

Bend PVC-U, M/F, Grey RAL 7011, FORSHEDA 601 POWER-LOCK® connection

D (mm)	E (mm)	L (mm)	Lc (mm)	L1 (mm)	Weight (gr)	PN16 Code	€
63	86	350	280	275	1.180	PBVPN16063F3L	45,43
75	102	280	280	355	1.690	PBVPN16075F3L	56,22
90	120	320	340	300	2.630	PBVPN16090F3L	62,93
110	144	315	295	300	2.930	PBVPN16110F3L	65,23
125	161	350	340	285	4.110	PBVPN16125F3L	74,02
140	178	330	375	315	5.610	PBVPN16140F3L	92,94
160	202	330	435	345	7.800	PBVPN16160F3L	117,56
180*	224	460	680	310	10.670	PBVPN16180S3L	282,64
200	238	475	680	295	13.710	PBVPN16200F3L	307,81
225	276	490	840	270	20.160	PBVPN16225F3L	383,19
250	305	490	840	370	24.700	PBVPN16250F3L	527,99
280	341	480	870	350	33.070	PBVPN16280F3L	745,37
315	382	590	870	390	41.880	PBVPN16315F3L	869,62
400	465	710	1070	720	85.590	PBVPN16400F3L	2.955,56

*Rubber ring

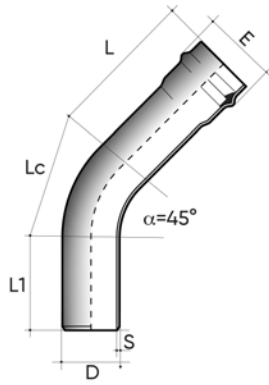

POWER-LOCK bend 45° M/F PN10 (BEND)

Bend PVC-U, M/F, Grey RAL 7011, FORSHEDA 601 POWER-LOCK® connection

D (mm)	E (mm)	L (mm)	Lc (mm)	L1 (mm)	Weight (gr)	PN10 Code	€
63	86	350	280	270	790	PBVPN10063F4L	32,52
75	102	280	280	355	1.120	PBVPN10075F4L	34,15
90	120	320	340	300	1.740	PBVPN10090F4L	37,57
110	144	315	295	300	1.930	PBVPN10110F4L	42,49
125	161	350	340	285	2.690	PBVPN10125F4L	51,11
140	178	330	375	315	3.610	PBVPN10140F4L	64,35
160	202	330	435	345	5.030	PBVPN10160F4L	87,71
180*	224	460	330	410	7.070	PBVPN10180S4L	181,77
200	238	470	330	400	10.950	PBVPN10200F4L	211,75
225	276	490	510	420	12.840	PBVPN10225F4L	274,33
250	305	510	520	370	15.900	PBVPN10250F4L	389,78
280	341	480	590	430	21.240	PBVPN10280F4L	487,62
315	382	540	510	450	26.950	PBVPN10315F4L	590,11
400	465	610	880	510	57.580	PBVPN10400F4L	1.102,54

*Rubber ring

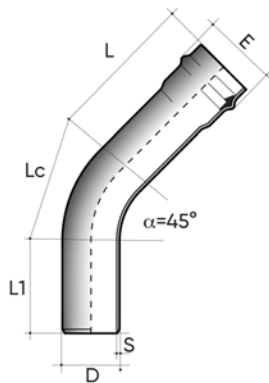

POWER-LOCK bend 45° M/F PN16 (BEND)

Bend PVC-U, M/F, Grey RAL 7011, FORSHEDA 601 POWER-LOCK® connection

D (mm)	E (mm)	L (mm)	Lc (mm)	L1 (mm)	Weight (gr)	PN16 Code	€
63	86	350	280	270	1.180	PBVPN16063F4L	45,43
75	102	280	280	355	1.690	PBVPN16075F4L	56,22
90	120	320	340	300	2.630	PBVPN16090F4L	62,93
110	144	315	295	300	2.930	PBVPN16110F4L	65,23
125	161	350	340	285	4.110	PBVPN16125F4L	74,02
140	178	330	375	315	5.610	PBVPN16140F4L	92,94
160	202	330	435	345	7.800	PBVPN16160F4L	117,56
180*	224	460	330	410	10.670	PBVPN16180S4L	282,64
200	238	470	330	400	13.710	PBVPN16200F4L	307,81
225	276	490	510	420	20.160	PBVPN16225F4L	383,19
250	305	510	520	370	24.700	PBVPN16250F4L	527,99
280	341	480	590	430	33.070	PBVPN16280F4L	745,37
315	382	540	510	450	41.880	PBVPN16315F4L	869,62
400	465	610	880	510	85.590	PBVPN16400F4L	2.955,56

*Rubber ring

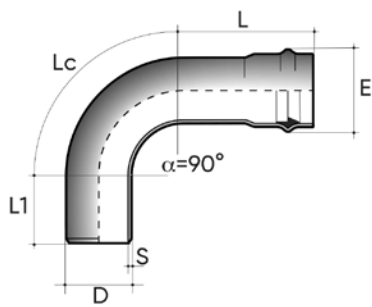

90° M/F PN10 POWER-LOCK bend (BEND)

Bend PVC-U, M/F, Grey RAL 7011, FORSHEDA 601 POWER-LOCK® connection

D (mm)	E (mm)	L (mm)	Lc (mm)	L1 (mm)	Weight (gr)	PN10 Code	€
63	86	265	350	255	790	PBVPN10063F9L	32,90
75	102	255	410	245	1.120	PBVPN10075F9L	34,69
90	120	285	480	275	1.850	PBVPN10090F9L	41,40
110	144	325	560	365	2.590	PBVPN10110F9L	46,64
125	161	320	685	260	3.360	PBVPN10125F9L	60,74
140	178	325	770	325	4.810	PBVPN10140F9L	84,79
160	202	360	880	230	6.440	PBVPN10160F9L	104,68
180*	224	490	780	440	9.430	PBVPN10180S9L	217,99
200	238	450	1460	270	15.340	PBVPN10200F9L	252,79
225	276	520	1710	380	23.390	PBVPN10225F9L	341,64
250	305	580	1720	390	28.400	PBVPN10250F9L	395,56
280	341	700	1930	480	42.480	PBVPN10280F9L	776,44
315	382	610	2240	450	57.480	PBVPN10315F9L	1.010,85

*Rubber ring

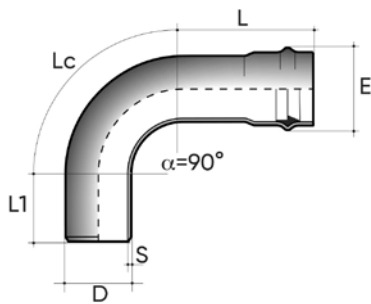

POWER-LOCK bend 90° M/F PN16 (BEND)

Bend PVC-U, M/F, Grey RAL 7011, FORSHEDA 601 POWER-LOCK® connection

D (mm)	E (mm)	L (mm)	Lc (mm)	L1 (mm)	Weight (gr)	PN16 Code	€
63	86	265	350	255	1.180	PBVPN16063F9L	49,97
75	102	255	410	245	1.690	PBVPN16075F9L	61,84
90	120	285	480	275	2.770	PBVPN16090F9L	69,22
110	144	325	560	365	3.290	PBVPN16110F9L	75,02
125	161	320	685	260	5.040	PBVPN16125F9L	85,61
140	178	325	770	325	7.170	PBVPN16140F9L	121,47
160	202	360	880	230	9.630	PBVPN16160F9L	146,75
180*	224	490	780	440	14.220	PBVPN16180S9L	338,64
200	238	450	1460	270	24.130	PBVPN16200F9L	366,71
225	276	520	1710	380	35.450	PBVPN16225F9L	487,62
250	305	580	1720	390	42.580	PBVPN16250F9L	615,32
280	341	700	1930	480	64.000	PBVPN16280F9L	1.084,09
315	382	610	2240	450	86.450	PBVPN16315F9L	1.333,15

*Rubber ring

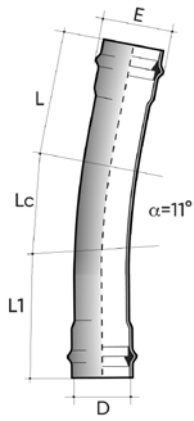

POWER-LOCK bend 11° F/F PN10 (BEND)

Bend PVC-U, F/F, Grey RAL 7011, FORSHEDA 601 POWER-LOCK® connection

D (mm)	E (mm)	L (mm)	Lc (mm)	L1 (mm)	Weight (gr)	PN10 Code	€
63	86	355	280	315	820	PBVPN10063FFIL	40,25
75	102	330	280	305	1.130	PBVPN10075FFIL	52,90
90	120	300	340	330	1.710	PBVPN10090FFIL	53,67
110	144	320	295	315	1.980	PBVPN10110FFIL	57,63
125	161	330	340	360	2.855	PBVPN10125FFIL	74,11
140	178	335	375	360	3.730	PBVPN10140FFIL	79,16
160	202	340	435	380	5.270	PBVPN10160FFIL	95,60
180*	224	560	280	560	9.430	PBVPN10180SS1L	210,06
200	238	560	280	560	11.700	PBVPN10200FFIL	230,63
225	276	545	310	545	14.680	PBVPN10225FFIL	308,78
250	305	570	310	570	21.000	PBVPN10250FFIL	448,25
280	341	555	340	555	23.370	PBVPN10280FFIL	560,76
315	382	565	370	565	29.650	PBVPN10315FFIL	678,63
400	465	750	450	800	63.340	PBVPN10400FFIL	1.267,92

*Rubber ring

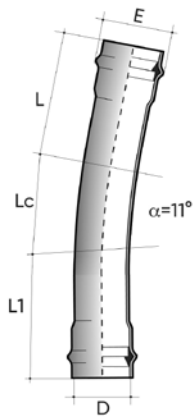

POWER-LOCK bend 11° F/F PN16 (BEND)

Bend PVC-U, F/F, Grey RAL 7011, FORSHEDA 601 POWER-LOCK® connection

D (mm)	E (mm)	L (mm)	Lc (mm)	L1 (mm)	Weight (gr)	PN16 Code	€
63	86	355	280	315	1.220	PBVPN16063FFIL	53,53
75	102	330	280	305	1.690	PBVPN16075FFIL	70,36
90	120	300	340	330	2.610	PBVPN16090FFIL	71,38
110	144	320	295	315	3.200	PBVPN16110FFIL	76,64
125	161	330	340	360	4.350	PBVPN16125FFIL	98,54
140	178	335	375	360	5.600	PBVPN16140FFIL	106,88
160	202	340	435	380	8.160	PBVPN16160FFIL	127,50
180*	224	560	280	560	14.220	PBVPN16180SS1L	325,04
200	238	560	280	560	17.550	PBVPN16200FFIL	353,98
225	276	545	310	545	22.240	PBVPN16225FFIL	410,78
250	305	570	310	570	31.510	PBVPN16250FFIL	607,19
280	341	555	340	555	39.470	PBVPN16280FFIL	857,18
315	382	565	370	565	49.950	PBVPN16315FFIL	1.000,06

*Rubber ring

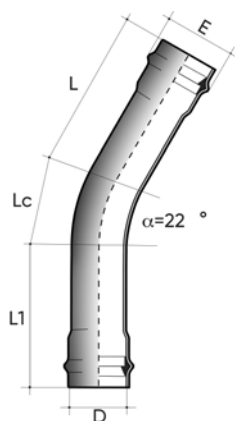

POWER-LOCK bend 22° F/F PN10 (BEND)

Bend PVC-U, F/F, Grey RAL 7011, FORSHEDA 601 POWER-LOCK® connection

D (mm)	E (mm)	L (mm)	Lc (mm)	L1 (mm)	Weight (gr)	PN10 Code	€
63	86	355	280	315	820	PBVPN10063FF2L	40,25
75	102	330	280	305	1.130	PBVPN10075FF2L	52,90
90	120	300	340	330	1.710	PBVPN10090FF2L	53,67
110	144	320	295	315	1.980	PBVPN10110FF2L	57,63
125	161	330	340	360	2.855	PBVPN10125FF2L	74,11
140	178	335	375	360	3.730	PBVPN10140FF2L	79,16
160	202	340	435	380	5.270	PBVPN10160FF2L	95,60
180*	224	635	330	635	9.430	PBVPN10180SS2L	210,06
200	238	635	330	635	11.700	PBVPN10200FF2L	230,63
225	276	545	510	545	14.680	PBVPN10225FF2L	308,78
250	305	665	520	665	21.000	PBVPN10250FF2L	448,25
280	341	530	590	530	23.370	PBVPN10280FF2L	560,76
315	382	570	510	570	29.650	PBVPN10315FF2L	678,63
400	465	660	880	660	63.340	PBVPN10400FF2L	1.267,92

*Rubber ring

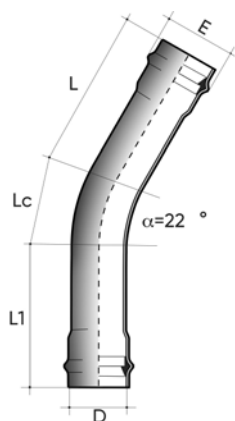

POWER-LOCK bend 22° F/F PN16 (BEND)

Bend PVC-U, F/F, Grey RAL 7011, FORSHEDA 601 POWER-LOCK® connection

D (mm)	E (mm)	L (mm)	Lc (mm)	L1 (mm)	Weight (gr)	PN16 Code	€
63	86	355	280	315	1.220	PBVPN16063FF2L	53,53
75	102	330	280	305	1.690	PBVPN16075FF2L	70,36
90	120	300	340	330	2.610	PBVPN16090FF2L	71,38
110	144	320	295	315	3.200	PBVPN16110FF2L	76,64
125	161	330	340	360	4.350	PBVPN16125FF2L	98,54
140	178	335	375	360	5.600	PBVPN16140FF2L	106,88
160	202	340	435	380	8.160	PBVPN16160FF2L	127,50
180*	224	635	330	635	14.220	PBVPN16180SS2L	325,04
200	238	635	330	635	17.550	PBVPN16200FF2L	353,98
225	276	545	510	545	22.240	PBVPN16225FF2L	410,78
250	305	665	520	665	31.510	PBVPN16250FF2L	607,19
280	341	530	590	530	39.470	PBVPN16280FF2L	857,18
315	382	570	510	570	49.950	PBVPN16315FF2L	1.000,06

*Rubber ring

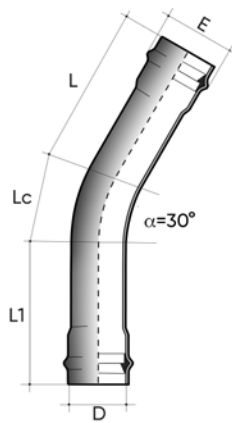

POWER-LOCK bend 30° F/F PN10 (BEND)

Bend PVC-U, F/F, Grey RAL 7011, FORSHEDA 601 POWER-LOCK® connection

D (mm)	E (mm)	L (mm)	Lc (mm)	L1 (mm)	Weight (gr)	PN10 Code	€
63	86	355	280	315	820	PBVPN10063FF3L	40,25
75	102	330	280	305	1.130	PBVPN10075FF3L	52,90
90	120	300	340	330	1.710	PBVPN10090FF3L	53,67
110	144	320	295	315	1.980	PBVPN10110FF3L	57,63
125	161	330	340	360	2.855	PBVPN10125FF3L	74,11
140	178	335	375	360	3.730	PBVPN10140FF3L	79,16
160	202	340	435	380	5.270	PBVPN10160FF3L	95,60
180*	224	540	680	540	9.430	PBVPN10180SS3L	210,06
200	238	550	680	540	11.700	PBVPN10200FF3L	230,63
225	276	505	840	505	14.680	PBVPN10225FF3L	308,78
250	305	580	840	580	21.000	PBVPN10250FF3L	448,25
280	341	565	870	565	23.370	PBVPN10280FF3L	560,76
315	382	615	870	615	29.650	PBVPN10315FF3L	678,63
400	465	810	1070	810	63.340	PBVPN10400FF3L	1.267,92

*Rubber ring

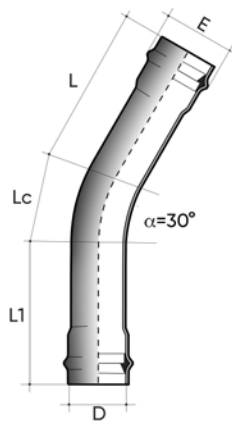

POWER-LOCK bend 30° F/F PN16 (BEND)

Bend PVC-U, F/F, Grey RAL 7011, FORSHEDA 601 POWER-LOCK® connection

D (mm)	E (mm)	L (mm)	Lc (mm)	L1 (mm)	Weight (gr)	PN16 Code	€
63	86	355	280	315	1.220	PBVPN16063FF3L	53,53
75	102	330	280	305	1.690	PBVPN16075FF3L	70,36
90	120	300	340	330	2.610	PBVPN16090FF3L	71,38
110	144	320	295	315	3.200	PBVPN16110FF3L	76,64
125	161	330	340	360	4.350	PBVPN16125FF3L	98,54
140	178	335	375	360	5.600	PBVPN16140FF3L	106,88
160	202	340	435	380	8.160	PBVPN16160FF3L	127,50
180*	224	540	680	540	14.220	PBVPN16180SS3L	325,04
200	238	550	680	540	17.550	PBVPN16200FF3L	353,98
225	276	505	840	505	22.240	PBVPN16225FF3L	410,78
250	305	580	840	580	31.510	PBVPN16250FF3L	607,19
280	341	565	870	565	39.470	PBVPN16280FF3L	857,18
315	382	615	870	615	49.950	PBVPN16315FF3L	1.000,06

*Rubber ring

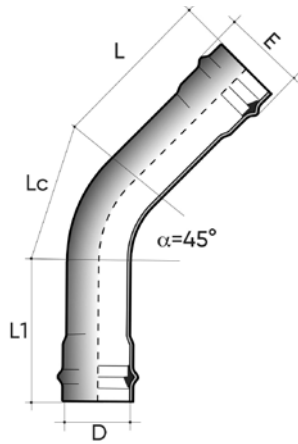

POWER-LOCK bend 45° F/F PN10 (BEND)

Bend PVC-U, F/F, Grey RAL 7011, FORSHEDA 601 POWER-LOCK® connection

D (mm)	E (mm)	L (mm)	Lc (mm)	L1 (mm)	Weight (gr)	PN10 Code	€
63	86	355	280	315	820	PBVPN10063FF4L	40,25
75	102	330	280	305	1.130	PBVPN10075FF4L	52,90
90	120	300	340	330	1.710	PBVPN10090FF4L	53,67
110	144	320	295	315	1.980	PBVPN10110FF4L	57,63
125	161	330	340	360	2.855	PBVPN10125FF4L	74,11
140	178	335	375	360	3.730	PBVPN10140FF4L	79,16
160	202	340	435	380	5.270	PBVPN10160FF4L	95,60
180*	224	540	680	540	9.430	PBVPN10180SS4L	210,06
200	238	550	680	540	11.700	PBVPN10200FF4L	230,63
225	276	505	840	505	14.680	PBVPN10225FF4L	308,78
250	305	580	840	580	21.000	PBVPN10250FF4L	448,25
280	341	565	870	565	23.370	PBVPN10280FF4L	560,76
315	382	615	870	615	29.650	PBVPN10315FF4L	678,63
400	465	810	1070	810	63.340	PBVPN10400FF4L	1.267,92

*Rubber ring

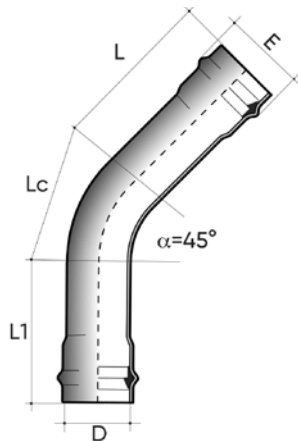

POWER-LOCK bend 45° F/F PN16 (BEND)

Bend PVC-U, F/F, Grey RAL 7011, FORSHEDA 601 POWER-LOCK® connection

D (mm)	E (mm)	L (mm)	Lc (mm)	L1 (mm)	Weight (gr)	PN16 Code	€
63	86	355	280	315	1.220	PBVPN16063FF4L	53,53
75	102	330	280	305	1.690	PBVPN16075FF4L	70,36
90	120	300	340	330	2.610	PBVPN16090FF4L	71,38
110	144	320	295	315	3.200	PBVPN16110FF4L	76,64
125	161	330	340	360	4.350	PBVPN16125FF4L	98,54
140	178	335	375	360	5.600	PBVPN16140FF4L	106,88
160	202	340	435	380	8.160	PBVPN16160FF4L	127,50
180*	224	540	680	540	14.220	PBVPN16180SS4L	325,04
200	238	550	680	540	17.550	PBVPN16200FF4L	353,98
225	276	505	840	505	22.240	PBVPN16225FF4L	410,78
250	305	580	840	580	31.510	PBVPN16250FF4L	607,19
280	341	565	870	565	39.470	PBVPN16280FF4L	857,18
315	382	615	870	615	49.950	PBVPN16315FF4L	1.000,06

*Rubber ring

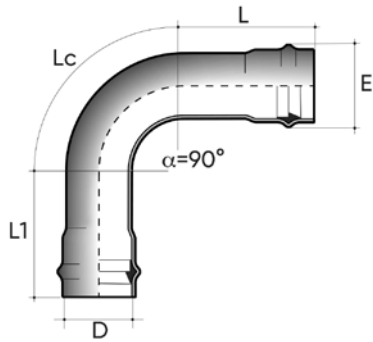

90° F/F PN10 POWER-LOCK bend (BEND)

Bend PVC-U, F/F, Grey RAL 7011, FORSHEDA 601 POWER-LOCK® connection

D (mm)	E (mm)	L (mm)	Lc (mm)	L1 (mm)	Weight (gr)	PN10 Code	€
63	86	270	350	270	770	PBVPN10063F1L	42,40
75	102	260	410	265	1.130	PBVPN10075F1L	53,15
90	120	280	480	290	1.820	PBVPN10090F1L	54,90
110	144	335	560	355	2.590	PBVPN10110F1L	58,60
125	161	320	685	320	3.480	PBVPN10125F1L	77,20
140	178	360	770	330	5.060	PBVPN10140F1L	97,51
160	202	335	880	315	6.720	PBVPN10160F1L	120,38
180*	224	560	780	590	10.900	PBVPN10180SS9L	250,69
200	238	560	1460	570	17.890	PBVPN10200F1L	290,71
225	276	660	1710	650	26.600	PBVPN10225F1L	392,89
250	305	660	1720	650	32.940	PBVPN10250F1L	454,89
280	341	745	1930	745	48.150	PBVPN10280F1L	892,91
315	382	680	2240	650	61.080	PBVPN10315F1L	1.162,48

*Rubber ring

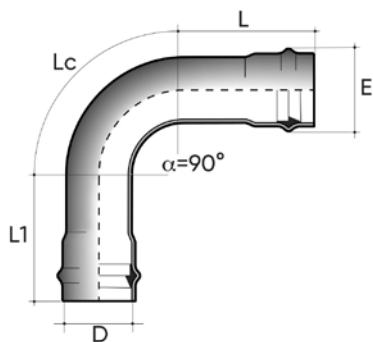

POWER-LOCK bend 90° F/F PN16 (BEND)

Bend PVC-U, F/F, Grey RAL 7011, FORSHEDA 601 POWER-LOCK® connection

D (mm)	E (mm)	L (mm)	Lc (mm)	L1 (mm)	Weight (gr)	PN16 Code	€
63	86	270	350	270	1.140	PBVPN16063FF9L	56,39
75	102	260	410	265	1.690	PBVPN16075FF9L	70,69
90	120	280	480	290	2.710	PBVPN16090FF9L	73,02
110	144	335	560	355	3.990	PBVPN16110FF9L	77,94
125	161	320	685	320	5.300	PBVPN16125FF9L	102,68
140	178	360	770	330	7.550	PBVPN16140FF9L	139,69
160	202	335	880	315	10.270	PBVPN16160FF9L	168,76
180*	224	560	780	590	16.890	PBVPN16180SS9L	389,44
200	238	560	1460	570	26.870	PBVPN16200FF9L	421,72
225	276	660	1710	650	41.010	PBVPN16225FF9L	560,76
250	305	660	1720	650	50.240	PBVPN16250FF9L	707,62
280	341	745	1930	745	72.530	PBVPN16280FF9L	1.246,70
315	382	680	2240	650	91.860	PBVPN16315FF9L	1.533,12

*Rubber ring

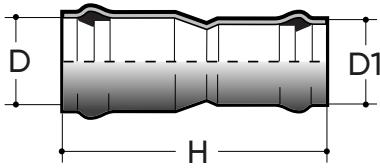

Reduced sleeve F/F PN10 (MARID)

Reduced sleeve PVC-U, F/F, Grey RAL 7011, Rubber ring connection,
FORSHEDA 601 POWER-LOCK on request

D x d (mm)	H (mm)	Weight (gr)	PN10 Code	€
75x63	330	476	MDVP10075063SSL	67,90
90x75	340	770	MDVP10090075SSL	83,30
110x90	418	1.493	MDVP10110090SSL	102,50
125x110	460	2.180	MDVP10125110SSL	135,80
140x125	508	3.056	MDVP10140125SSL	138,40
160x140	552	4.770	MDVP10160140SSL	171,66
180x160	598	6.715	MDVP10180160SSL	292,30
200x180	658	8.480	MDVP10200180SSL	297,20
225x200	677	10.500	MDVP10225200SSL	331,20
250x225	696	14.410	MDVP10250225SSL	426,90
280x250	723	17.950	MDVP10280250SSL	499,87
315x280**	1.140	21.190	MDVP08315280SSL	681,65
55x315***	1.150	25.840	MDVP05355315SSL	1.155,74
400x355***	1.150	33.600	MDVP05400355SSL	1.403,15

**PN8

***PN5

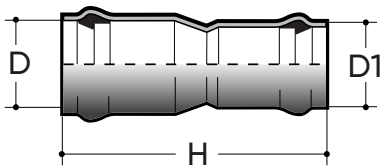

Reduced sleeve F/F PN16 (MARID)

Reduced sleeve PVC-U, F/F, Grey RAL 7011, Rubber ring connection,
FORSHEDA 601 POWER-LOCK on request

D x d (mm)	H (mm)	Weight (gr)	PN16 Code	€
75x63	330	520	MDVP16075063SSL	88,26
90x75	340	970	MDVP16090075SSL	108,25
110x90	418	2000	MDVP16110090SSL	133,20
125x110	460	2450	MDVP16125110SSL	176,55
140x125	508	3835	MDVP16140125SSL	211,60
160x140	552	5670	MDVP16160140SSL	245,02

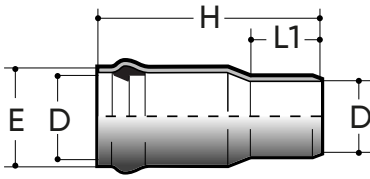

Single-joint M/F PN10 (MONOG)

PVC-U Sleeve, M/F, RAL 7011 Grey, FORSHEDA 601 POWER-LOCK® connection

D (mm)	E (mm)	L1 (mm)	H (mm)	Weight (gr)	PN10 Code	€
63	86	46	185	170	MGVP100630FL	16,83
75	102	52	200	254	MGVP100750FL	22,97
90	120	60	210	390	MGVP100900FL	25,77
110	144	70	220	484	MGVP101100FL	29,47
125	161	80	245	693	MGVP101250FL	36,66
140	178	85	265	958	MGVP101400FL	40,52
160	202	95	280	1.316	MGVP101600FL	53,98
180*	224	105	320	1.890	MGVP101800SL	62,58
200	238	115	340	2500	MGVP102000FL	71,47
225	276	130	355	3400	MGVP102250FL	86,06
250	305	140	380	5000	MGVP102500FL	110,38
280	341	155	400	6000	MGVP102800FL	139,69
315	382	175	450	8090	MGVP103150FL	164,21

*Rubber ring

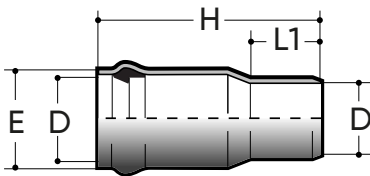

Single-joint M/F PN16 (MONOG)

PVC-U Sleeve, M/F, RAL 7011 Grey, FORSHEDA 601 POWER-LOCK® connection

D (mm)	E (mm)	L1 (mm)	H (mm)	Weight (gr)	PN16 Code	€
63	86	46	185	250	MGVP160630FL	22,38
75	102	52	200	380	MGVP160750FL	30,55
90	120	60	210	570	MGVP160900FL	34,27
110	144	70	220	730	MGVP161100FL	39,19
125	161	80	245	1.040	MGVP161250FL	48,76
140	178	85	265	1.430	MGVP161400FL	53,89
160	202	95	280	1.970	MGVP161600FL	71,79
180*	224	105	320	2.850	MGVP161800SL	94,57
200	238	115	340	3.730	MGVP162000FL	118,66
225	276	130	355	4.950	MGVP162250FL	135,01
250	305	140	380	6.470	MGVP162500FL	168,76
280	341	155	400	8.500	MGVP162800FL	303,77
315	382	175	450	12.200	MGVP163150FL	337,53

*Rubber ring

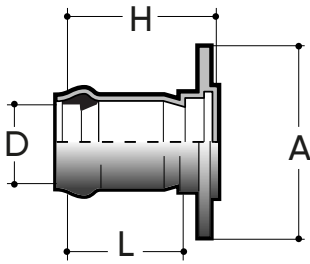

Single-joint Flanged PN10 (TOULIPE)

Single-joint Flanged PVC-U, M/F, Grey RAL 7011, FORSHEDA 601 POWER-LOCK® connection

D x dn (mm)	Ø H x n. holes (mm)	L (mm)	H (mm)	Weight (gr)	PN10 Code	€
63x50	125x4	120	225	572	TPVP10063050FBL	49,51
75x65	145x4	120	230	769	TPVP10075065FBL	66,26
90x80	160x8	120	240	1.092	TPVP10090080FBL	76,53
110x100	180x8	130	250	1.449	TPVP10110100FBL	95,31
125x110	210x8	140	275	1.846	TPVP10125110FBL	106,20
140x125	210x8	160	295	2.409	TPVP10140125FBL	116,68
160x150	240x8	160	310	3.000	TPVP10160150FBL	132,74
180x180*	270x8	180	350	5.035	TPVP10180180SBL	216,04
200x200	295x8	200	370	5.200	TPVP10200200FBL	223,16
225x200	295x8	210	390	6.300	TPVP10225200FBL	308,78
250x250	350x12	220	410	8.500	TPVP10250250FBL	448,25
280x250	350x12	230	430	12.864	TPVP10280250FBL	587,02
315x300**	400x12	230	480	15.362	TPVP08315300FBL	678,63

*Rubber ring

**PN8

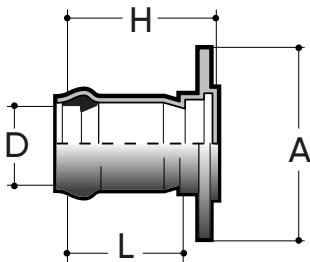

Single-joint Flanged PN16 (TOULIPE)

Single-joint Flanged PVC-U, M/F, Grey RAL 7011, FORSHEDA 601 POWER-LOCK® connection

D x dn (mm)	Ø H x n. holes (mm)	L (mm)	H (mm)	Weight (gr)	PN16 Code	€
63x50	125x4	120	225	653	TPVP16063050FBL	65,84
75x65	145x4	120	230	893	TPVP16075065FBL	88,13
90x80	160x8	120	240	1.333	TPVP16090080FBL	101,78
110x100	180x8	130	250	1.533	TPVP16110100FBL	126,76
125x110	210x8	140	275	2.257	TPVP16125110FBL	141,25
140x125	210x8	160	295	3.013	TPVP16140125FBL	155,18
160x150	240x8	160	310	3.600	TPVP16160150FBL	176,54

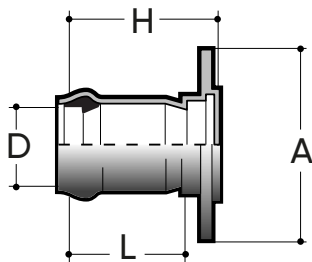

Reduction with Flange PN10 (REDUCED TOULIPE)

Reduced Toulip PVC-U, M/F, Grey RAL 7011, FORSHEDA 601 POWER-LOCK® connection

D x dn (mm)	∅ H x n. holes (mm)	L (mm)	H (mm)	Weight (gr)	PN10 Code	€
75x50	125x4	120	350	769	TRVP10075050FBL	66,26
90x50	125x4	120	365	1.092	TRVP10090050FBL	80,79
90x65	145x4	120	365	1.092	TRVP10090065FBL	80,79
110x50	125x4	130	390	1.449	TRVP10110050FBL	109,81
110x65	145x4	130	390	1.449	TRVP10110065FBL	109,81
110x80	160x8	130	390	1.449	TRVP10110080FBL	109,81
125x50	125x4	140	420	1.846	TRVP10125050FBL	149,67
125x65	145x4	140	420	1.846	TRVP10125065FBL	149,67
125x80	160x8	140	420	1.846	TRVP10125080FBL	149,67
125x100	180x8	140	420	1.846	TRVP10125100FBL	149,67
140x50	125x4	160	460	2.409	TRVP10140050FBL	189,76
140x65	145x4	160	460	2.409	TRVP10140065FBL	189,76
140x80	160x8	160	460	2.409	TRVP10140080FBL	189,76
140x100	180x8	160	460	2.409	TRVP10140100FBL	189,76
160x80	160x8	160	500	3.321	TRVP10160080FBL	192,18
160x100	180x8	160	500	3.321	TRVP10160100FBL	192,18
160x125	210x8	160	500	3.321	TRVP10160125FBL	192,18
200x80	160x8	200	620	5.632	TRVP10200080FBL	380,46
200x100	180x8	200	620	5.632	TRVP10200100FBL	380,46
200x125	210x8	200	620	5.632	TRVP10200125FBL	380,46
200x150	240x8	200	620	5.632	TRVP10200150FBL	380,46

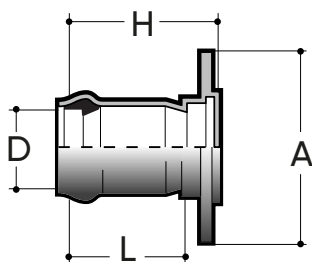

Reduction with Flange PN16 (REDUCED TOULIPE)

Reduced Toulip PVC-U, M/F, Grey RAL 7011, FORSHEDA 601 POWER-LOCK® connection

D x dn (mm)	∅ H x n. holes (mm)	L (mm)	H (mm)	Weight (gr)	PN 16 Code	€
75x50	125x4	120	350	893	TRVP16075050FBL	88,13
90x50	125x4	120	365	1.333	TRVP16090050FBL	107,45
90x65	145x4	120	365	1.333	TRVP16090065FBL	107,45
110x50	125x4	130	390	1.533	TRVP16110050FBL	146,05
110x65	145x4	130	390	1.533	TRVP16110065FBL	146,05
110x80	160x8	130	390	1.533	TRVP16110080FBL	146,05
125x50	125x4	140	420	2.257	TRVP16125050FBL	199,06
125x65	145x4	140	420	2.257	TRVP16125065FBL	199,06
125x80	160x8	140	420	2.257	TRVP16125080FBL	199,06
125x100	180x8	140	420	2.257	TRVP16125100FBL	199,06
140x50	125x4	160	460	3.013	TRVP16140050FBL	252,38
140x65	145x4	160	460	3.013	TRVP16140065FBL	252,38
140x80	160x8	160	460	3.013	TRVP16140080FBL	252,38
140x100	180x8	160	460	3.013	TRVP16140100FBL	252,38
160x80	160x8	160	500	4.114	TRVP16160080FBL	255,60
160x100	180x8	160	500	4.114	TRVP16160100FBL	255,60
160x125	210x8	160	500	4.114	TRVP16160125FBL	255,60

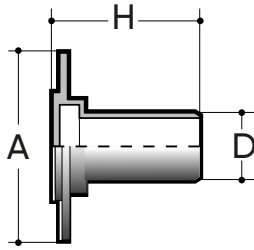

PN10 Male Adapter (BOUT)

PVC-U Adapter, M/M, RAL 7011 Grey, FORSHEDA 601 POWER-LOCK® connection

D (mm)	Ø H x n. holes (mm)	H (mm)	Weight (gr)	PN10 Code	€
63x50	125x4	200	567	BOVP100630500BL	40,22
75x65	145x4	200	744	BOVP100750650BL	42,59
90x80	160x8	230	1.092	BOVP100900800BL	53,49
110x100	180x8	240	1.449	BOVP101101000BL	66,82
125x110	190x8	240	1.775	BOVP101251100BL	80,16
140x125	210x8	260	2.319	BOVP101401250BL	96,22
160x150	240x8	300	3.321	BOVP101601500BL	97,55
180x180	270x8	320	4.917	BOVP101801800BL	261,22
200x200	295x8	340	5.486	BOVP102002000BL	186,78
225x200	295x8	360	5.968	BOVP102252000BL	221,21
250x225	350x12	400	8.147	BOVP102502250BL	314,84
280x250	350x12	420	12.864	BOVP102802500BL	612,85
*315x300	400x12	470	*15.362	BOVP083153000BL	489,54

* PN8

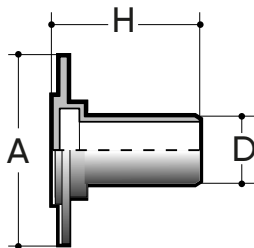

PN16 Male Adapter (BOUT)

PVC-U Adapter, M/M, RAL 7011 Grey, FORSHEDA 601 POWER-LOCK® connection

D (mm)	Ø H x n. holes (mm)	H (mm)	Weight (gr)	PN16 Code	€
63x50	125x4	200	646	BOVP160630500BL	53,49
75x65	145x4	200	855	BOVP160750650BL	56,65
90x80	160x8	230	1.279	BOVP160900800BL	71,14
110x100	180x8	240	1.475	BOVP161101000BL	88,87
125x110	190x8	240	2.088	BOVP161251100BL	106,61
140x125	210x8	260	2.744	BOVP161401250BL	127,97
160x150	240x8	300	3.973	BOVP161601500BL	129,74

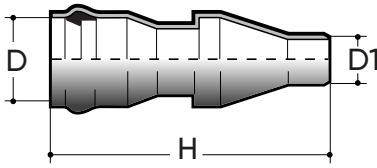

Reduced single-joint/male PN10 (REDUCER)

Reduced joint PVC-U, F/M, Grey RAL 7011, Rubber ring connection,
FORSHEDA 601 POWER-LOCK on request

D x D1 (mm)	H (mm)	Weight (gr)	PN10 Code	€
75x63	300	460	REVP100750630SL	61,73
90x63	315	720	REVP100900630SL	69,96
90x75	320	740	REVP100900750SL	75,69
110x63	380	1.340	REVP101100630SL	83,44
110x75	390	1.380	REVP101100750SL	84,14
110x90	400	1.440	REVP101100900SL	93,15
125x90	440	2.050	REVP101250900SL	113,12
125x110	450	2.110	REVP101251100SL	123,45
140x110	490	2.870	REVP101401100SL	125,82
140x125	500	2.960	REVP101401250SL	125,82
160x110	530	4.500	REVP101601100SL	156,06
160x140	540	4.600	REVP101601400SL	156,06
180x160	580	6.500	REVP101801600SL	265,75
200x160	640	8.100	REVP102001600SL	270,19
225x160	650	9.800	REVP102251600SL	301,10
250x200	680	12.200	REVP102502000SL	346,79
280x225	700	15.000	REVP102802250SL	409,50
315x250**	1500	*20.300	REVP083152500SL	441,00

**PN8

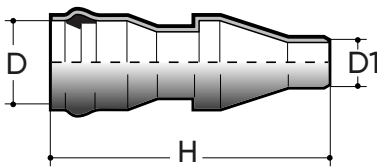

Reduced single-joint / male PN16 (REDUCER)

Reduced joint PVC-U, F/M, Grey RAL 7011, Rubber ring connection,
FORSHEDA 601 POWER-LOCK on request

D x D1 (mm)	H (mm)	Weight (gr)	PN16 Code	€
75x63	300	500	REVP160750630SL	80,24
90x63	315	920	REVP160900630SL	90,95
90x75	320	940	REVP160900750SL	98,40
110x63	380	1.780	REVP161100630SL	108,47
110x75	390	1.850	REVP161100750SL	109,38
110x90	400	1.930	REVP161100900SL	121,09
125x90	440	2.250	REVP161250900SL	147,05
125x110	450	2.370	REVP161251100SL	160,49
140x110	490	3.600	REVP161401100SL	163,57
140x125	500	3.700	REVP161401250SL	163,57
160x110	530	5.300	REVP161601100SL	202,88
160x140	540	5.400	REVP161601400SL	202,88

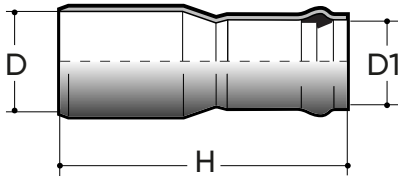

M/F increase with PN10 rubber ring (INCREASE)

Increase PVC-U, M/F, Grey RAL 7011, Rubber ring connection, FORSHEDA 601 POWER-LOCK® on request

D x D1 (mm)	H (mm)	Weight (gr)	PN10 Code	€
90x75	238	480	AUVP100900750SL	51,67
110x75	246	635	AUVP101100750SL	53,77
110x90	246	670	AUVP101100900SL	57,20
125x110	281	1.450	AUVP101251100SL	88,26
140x110	292,5	1.670	AUVP101401100SL	92,52
160x110	307	1.970	AUVP101601100SL	112,77
200x160	364,5	3.450	AUVP102001600SL	143,14
225x160	387	4.140	AUVP102251600SL	159,20

Upon request PN 16

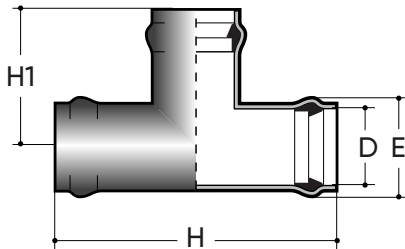

Tee at 90° F/F PN10 (MONOLITHIC TEE90)

90° bypass PVC-U, F/F, Grey RAL 7011, Rubber ring connection, FORSHEDA 601 POWER-LOCK® on request

D x D1 (mm)	E (mm)	H (mm)	H1 (mm)	Weight (gr)	PN10 Code	€
63	92	274	137	780	T9VP10063SSL	38,73
75	107	300	150	1.140	T9VP10075SSL	59,50
90	126	330	165	1.745	T9VP10090SSL	80,28
110	151	370	185	2.745	T9VP10110SSL	133,88
125	169	400	200	3.700	T9VP10125SSL	178,53
140	178	650	325	7.440	T9VP10140SSL	252,87
160	213	462	231	6.835	T9VP10160SSL	327,28
*180	224	788	394	14.310	T9VP10180SSL	479,56
200	262	545	273	12.500	T9VP10200SSL	498,60
*225	276	864	432	24.950	T9VP10225SSL	877,74
*250	305	1.012	506	29.500	T9VP10250SSL	1.220,86
*280	341	1.020	510	39.230	T9VP10280SSL	1.934,08
*315	382	1.194	597	55.000	** T9VP08315SSL	2.454,55

* Assembled
** PN8

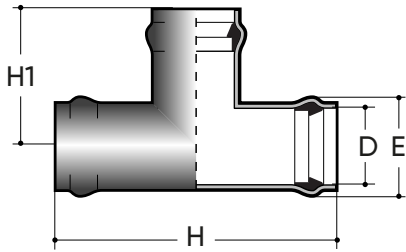

Tee at 90° F/F PN16 (MONOLITHIC TEE90)

90° bypass PVC-U, F/F, Grey RAL 7011, Rubber ring connection, FORSHEDA 601 POWER-LOCK® on request

D x D1 (mm)	E (mm)	H (mm)	H1 (mm)	Weight (gr)	PN16 Code	€
* 63	92	274	137	1.014	T9VP16063SSL	51,51
75	107	300	150	1.482	T9VP16075SSL	79,13
90	126	330	165	2.269	T9VP16090SSL	106,77
110	151	370	185	3.569	T9VP16110SSL	178,05
125	169	400	200	4.810	T9VP16125SSL	237,44
140	178	650	325	9.672	T9VP16140SSL	336,31
160	213	462	231	8.886	T9VP16160SSL	435,29

*Assembled

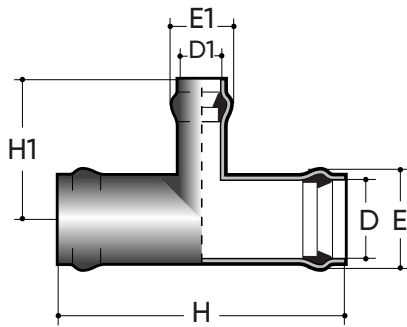

90° tee with reduced lead PN10 (TERID)

Shunt reduced to 90° PVC-U, Grey RAL 7011, Rubber ring connection, FORSHEDA 601 POWER-LOCK® on request

D x D1 (mm)	H (mm)	H1 (mm)	E (mm)	E1 (mm)	Weight (gr)	PN10 Code	€
75x63	300	144	107	92	1130	TRVP10075063SSL	65,22
90x63	330	154	126	92	1.530	TRVP10090063SSL	88,12
90x75	330	160	126	107	1.600	TRVP10090075SSL	88,12
110x63	370	166	151	92	2.300	TRVP10110063SSL	146,84
110x75	370	172	151	107	2.385	TRVP10110075SSL	146,84
110x90	370	177	151	126	2.530	TRVP10110090SSL	146,84
125x63	400	173	169	92	3.230	TRVP10125063SSL	195,79
125x75	400	179	169	107	3.300	TRVP10125075SSL	195,79
125x90	400	184	169	126	3.390	TRVP10125090SSL	195,79
125x110	400	192	169	92	3.545	TRVP10125110SSL	195,79
140x63	630	283	178	151	4.825	TRVP10140063SSL	279,02
140x75	630	285	178	86	4.910	TRVP10140075SSL	279,02
140x90	630	291	178	101	5.070	TRVP10140090SSL	279,02
140x110	630	303	178	119	5.300	TRVP10140110SSL	279,02
140x125	630	309	178	143	5.575	TRVP10140125SSL	279,02
160x63	462	195	213	160	5.540	TRVP10160063SSL	359,81
160x75	462	201	213	92	5.625	TRVP10160075SSL	359,81
160x90	462	206	213	107	5.780	TRVP10160090SSL	359,81
160x110	462	214	213	126	5.970	TRVP10160110SSL	359,81
160x125	462	222	213	69	6.225	TRVP10160125SSL	359,81
160x140	462	225	213	178	6.500	TRVP10160140SSL	359,81
200x63	545	221	262	92	9.460	TRVP10200063SSL	523,83
200x75	545	227	262	107	9.545	TRVP10200075SSL	523,83
200x90	545	232	262	126	9.700	TRVP10200090SSL	523,83
200x110	545	240	262	151	9.890	TRVP10200110SSL	523,83
200x125	545	248	262	169	10.145	TRVP10200125SSL	523,83
200x140	545	251	262	178	10.665	TRVP10200140SSL	523,83
200x160	545	266	262	213	11.190	TRVP10200160SSL	523,83
225x160	906	442	276	247	23.800	TRVP10225160SSL	920,00
250x160	994	494	305	276	28.175	TRVP10250160SSL	1.320,00
280x200	1.060	544	341	305	37.250	TRVP10280200SSL	2.012,00
*315x250	1.176	582	381	305	50.515	TRVP08315250SSL	2.650,00

*PN8

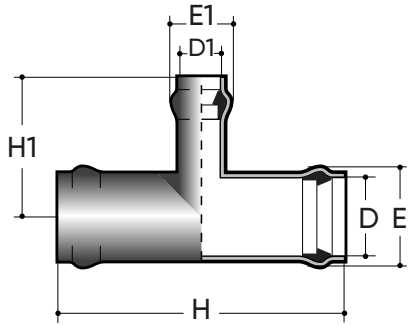

90° tee with reduced lead PN16 (TERID)

Shunt reduced to 90° PVC-U, Grey RAL 7011, Rubber ring connection, FORSHEDA 601 POWER-LOCK® on request

D x D1 (mm)	E (mm)	E1 (mm)	H (mm)	H1 (mm)	Weight (gr)	PN16 Code	€
75x63	300	144	107	92	1.469	TRVP16075063SSL	86,74
90x63	330	154	126	92	1.989	TRVP16090063SSL	117,20
90x75	330	160	126	107	2.080	TRVP16090075SSL	117,20
110x63	370	166	151	92	2.990	TRVP16110063SSL	195,30
110x75	370	172	151	107	3.101	TRVP16110075SSL	195,30
110x90	370	177	151	126	3.289	TRVP16110090SSL	195,30
125x63	400	173	169	92	4.199	TRVP16125063SSL	260,40
125x75	400	179	169	107	4.290	TRVP16125075SSL	260,40
125x90	400	184	169	126	4.407	TRVP16125090SSL	260,40
125x110	400	192	169	92	4.609	TRVP16125110SSL	260,40
140x63	630	283	178	151	6.273	TRVP16140063SSL	371,10
140x75	630	285	178	86	6.383	TRVP16140075SSL	371,10
140x90	630	291	178	101	6.591	TRVP16140090SSL	371,10
140x110	630	303	178	119	6.890	TRVP16140110SSL	371,10
140x125	630	309	178	143	7.248	TRVP16140125SSL	371,10
160x63	462	195	213	160	7.202	TRVP16160063SSL	478,54
160x75	462	201	213	92	7.313	TRVP16160075SSL	478,54
160x90	462	206	213	107	7.514	TRVP16160090SSL	478,54
160x110	462	214	213	126	7.761	TRVP16160110SSL	478,54
160x125	462	222	213	69	8.093	TRVP16160125SSL	478,54
160x140	462	225	213	178	8.450	TRVP16160140SSL	478,54

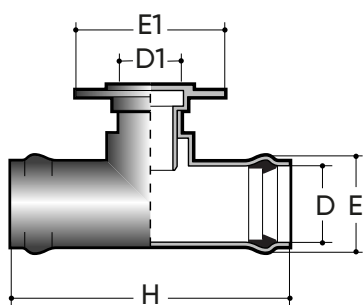

90° flanged tee PN10 (TRFLA)

Shunt reduced to 90° flanged PVC-U, Grey RAL 7011, Rubber ring connection, FORSHEDA 601
POWER-LOCK® on request

D x D1 (mm)	E (mm)	E1 (mm)	ØA x nr. Holes (mm)	H (mm)	Weight (gr)	PN10 Code	€
63x50	92	168	125x4	274	1.125	TFVP10063050SBL	69,84
75x50	107	168	125x4	300	1.580	TFVP10075050SBL	88,12
75x65	107	188	145x4	300	1.590	TFVP10075065SBL	88,12
90x50	126	168	125x4	330	1.925	TFVP10090050SBL	121,22
90x65	126	188	145x4	330	2.110	TFVP10090065SBL	121,22
90x80	126	203	160x8	330	2.530	TFVP10090080SBL	121,22
110x50	151	168	125x4	370	2.696	TFVP10110050SBL	178,96
110x65	151	168	145x4	370	2.920	TFVP10110065SBL	178,96
110x80	151	203	160x8	370	3.240	TFVP10110080SBL	178,96
110x100	151	222	180x8	370	3.920	TFVP10110100SBL	178,96
125x50	169	168	125x4	400	3.790	TFVP10125050SBL	224,70
125x65	169	188	145x4	400	3.952	TFVP10125065SBL	224,70
125x80	169	203	160x8	400	4.123	TFVP10125080SBL	224,70
125x100	169	222	180x8	400	4.534	TFVP10125100SBL	224,70
125x110	169	230	190x8	400	5.440	TFVP10125110SBL	224,70
140x50	189	168	125x4	426	4.796	TFVP10140050SBL	315,28
140x65	189	188	145x4	426	4.995	TFVP10140065SBL	315,28
140x80	189	203	160x8	426	5.320	TFVP10140080SBL	315,28
140x100	189	222	180x8	426	5.870	TFVP10140100SBL	315,28
140x110	189	230	190x8	426	6.000	TFVP10140110SBL	315,28
140x125	178	251	210x8	630	7.850	TFVP10140125SBL	315,28
160x50	213	168	125x4	462	6.200	TFVP10160050SBL	418,68
160x65	213	188	145x4	462	6.335	TFVP10160065SBL	418,68
160x80	213	203	160x8	462	6.510	TFVP10160080SBL	418,68
160x100	213	222	180x8	462	6.954	TFVP10160100SBL	418,68
160x110	213	230	190x8	462	7.384	TFVP10160110SBL	418,68
160x125	213	251	210x8	462	7.895	TFVP10160125SBL	418,68
160x150	213	290	240x8	462	9.340	TFVP10160150SBL	418,68
180x180	224	318	270x8	780	9.600	TFVP10180180SBL	499,00
200x50	262	168	125x4	545	9.870	TFVP10200050SBL	523,83
200x65	262	188	145x4	545	10.080	TFVP10200065SBL	523,83
200x80	262	203	160x8	545	10.435	TFVP10200080SBL	523,83
200x100	262	222	180x8	545	10.880	TFVP10200100SBL	523,83
200x110	262	230	190x8	545	11.304	TFVP10200110SBL	523,83
200x125	262	251	210x8	545	12.060	TFVP10200125SBL	523,83
200x150	262	290	240x8	545	13.345	TFVP10200150SBL	523,83
200x200	262	340	295x8	545	14.490	TFVP10200200SBL	523,83
225x150	276	290	240x8	906	21.450	TFVP10225150SBL	920,00
225x200	276	340	295x8	906	23.720	TFVP10225200SBL	920,00
250x225	305	396	350x12	994	28.025	TFVP10250225SBL	1.320,00
280x280	342	399	350x12	1.180	32.200	TFVP10280280SBL	2.012,00
*315x300	381	465	400x12	1.176	53.100	TFVP08315300SBL	2.650,00

* PN 8

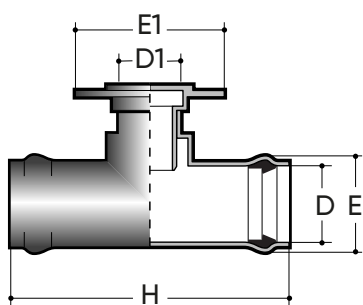

90° flanged tee PN16 (TRFLA)

Shunt reduced to 90° flanged PVC-U, Grey RAL 7011, Rubber ring connection, FORSHEDA 601 POWER-LOCK® on request

D x D1 (mm)	E (mm)	E1 (mm)	ØA x nr. Holes (mm)	H (mm)	Weight (gr)	PN16 Code	€
63x50	274	92	168	125x4	1.463	TFVP16063050SBL	118,28
75x50	300	107	168	125x4	2.054	TFVP16075050SBL	124,62
75x65	300	107	188	145x4	2.067	TFVP16075065SBL	124,62
90x50	330	126	168	125x4	2.503	TFVP16090050SBL	161,22
90x65	330	126	188	145x4	2.743	TFVP16090065SBL	161,22
90x80	330	126	203	160x8	3.289	TFVP16090160SBL	161,22
110x50	370	151	168	125x4	3.505	TFVP16110050SBL	238,02
110x65	370	151	168	145x4	3796	TFVP16110065SBL	238,02
110x80	370	151	203	160x8	4212	TFVP16110160SBL	238,02
110x100	370	151	222	180x8	5096	TFVP16110100SBL	238,02
125x50	400	169	168	125x4	4927	TFVP16125050SBL	298,85
125x65	400	169	188	145x4	5138	TFVP16125065SBL	298,85
125x80	400	169	203	160x8	5360	TFVP16125160SBL	298,85
125x100	400	169	222	180x8	5.894	TFVP16125100SBL	298,85
125x110	400	169	230	190x8	7.072	TFVP16125110SBL	298,85
140x50	426	189	168	125x4	6.235	TFVP16140050SBL	419,32
140x65	426	189	188	145x4	6.494	TFVP16140065SBL	419,32
140x80	426	189	203	160x8	6.916	TFVP16140160SBL	419,32
140x100	426	189	222	180x8	7.631	TFVP16140100SBL	419,32
140x110	426	189	230	190x8	7.800	TFVP16140110SBL	419,32
140x125	630	178	251	210x8	10.205	TFVP16140125SBL	419,32
160x50	462	213	168	125x4	8.060	TFVP16160050SBL	556,84
160x65	462	213	188	145x4	8.236	TFVP16160065SBL	556,84
160x80	462	213	203	160x8	8.463	TFVP16160160SBL	556,84
160x100	462	213	222	180x8	9.040	TFVP16160100SBL	556,84
160x110	462	213	230	190x8	9.599	TFVP16160110SBL	556,84
160x125	462	213	251	210x8	10.264	TFVP16160125SBL	556,84
160x150	462	213	290	240x8	12.142	TFVP16160150SBL	556,84

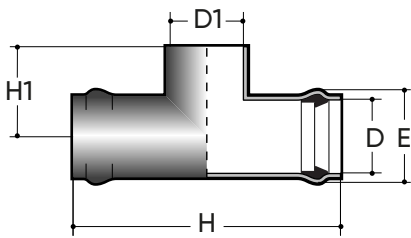

90° tee for PN10 gluing (Monolithic TETRA)

90° bypass PVC-U, Grey RAL 7011, Rubber Ring connection/gluing

D - D1 (mm)	H (mm)	H1 (mm)	E (mm)	Weight (gr)	PN10 Code	€
63	274	77	92	630	TGVP10063ISL	29,41
75	300	90	107	915	TGVP10075ISL	49,46
90	330	107	126	1.575	TGVP10090ISL	54,80
110	370	129	151	2.450	TGVP10110ISL	88,21
125	400	144	169	3.350	TGVP10125ISL	120,28
140	650	153	189	6.340	TGVP10140ISL	283,34
160	462	186	213	7.000	TGVP10160ISL	291,36
200	545	229	262	9.800	TGVP10200ISL	372,07

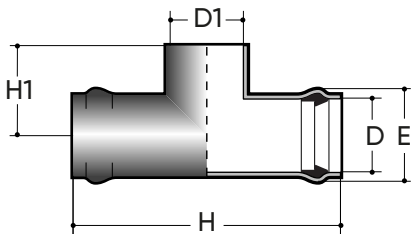

90° tee for gluing PN16 (Monolithic TETRA)

90° bypass PVC-U, Grey RAL 7011, Rubber Ring connection/gluing

D - D1 (mm)	H (mm)	H1 (mm)	E (mm)	Weight (gr)	PN16 Code	€
63	274	77	92	760	TGVP16063ISL	35,29
75	300	90	107	1.100	TGVP16075ISL	59,35
90	330	107	126	1.890	TGVP16090ISL	65,76
110	370	129	151	2.950	TGVP16110ISL	108,85
125	400	144	169	4.000	TGVP16125ISL	144,34
140	650	153	189	7.600	TGVP16140ISL	340,00
160	462	186	213	8.400	TGVP16160ISL	349,63

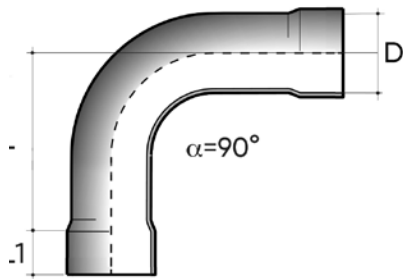

Thermoformed bend R=1.5D 90° F/F PN10 (THERMOFORMED CURVES)

Bend PVC-U, F/F, Grey RAL 7011, gluing connection

D (mm)	L (mm)	L1 (mm)	PN10 Code	€
50	92	35	B9VP10050IIL	5,87
63	102	43	B9VP10063IIL	9,02
75	118	51	B9VP10075IIL	11,83
90	142	58	B9VP10090IIL	22,95
*110	175	70	B9VP12110IIL	40,45
*125	200	79	B9VP12125IIL	51,56
*140	236	87	B9VP12140IIL	80,88
*160	260	99	B9VP12160IIL	105,17
*200	330	122	B9VP12180IIL	197,16

*PN12,5

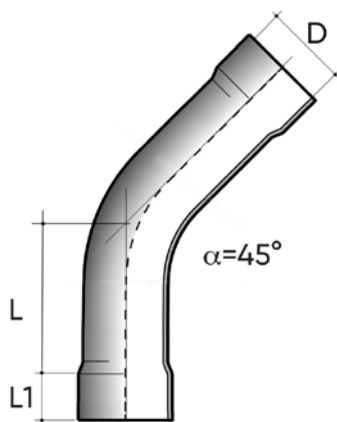

Thermoformed bend R=1.5D 45° F/F PN10 (THERMOFORMED CURVES)

Bend PVC-U, F/F, Grey RAL 7011, gluing connection

D (mm)	L (mm)	L1 (mm)	PN10 Code	€
50	40	35	B4VP10050IIL	5,10
63	46	43	B4VP10063IIL	7,87
75	54	51	B4VP10075IIL	9,21
90	63	58	B4VP10090IIL	19,20
*110	80	70	B4VP12110IIL	32,57
*125	89	79	B4VP12125IIL	44,06
*140	98	87	B4VP12140IIL	72,78
*160	119	99	B4VP12160IIL	85,32
*200	143	122	B4VP12180IIL	155,72

*PN12,5



PVC sewer guillotine gate

PVC gate

D (mm)	Code	€
110	SEVP001100SL	188,00
125	SEVP001250SL	205,00
160	SEVP001600SL	225,00
200	SEVP002000SL	335,00
250	SEVP002500SL	390,00
315	SEVP003150SL	525,00
400	SEVP004000SL	720,00
500	SEVP005000SL	920,00
630	SEVP006300SL	2.070,00

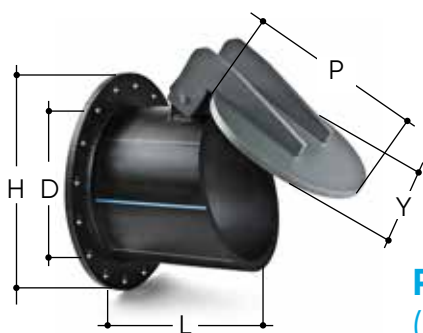

PE Clapet Valve (CLAPET)

Polyethylene Clapet Valve

D (mm)	H (mm)	L (mm)	Y (mm)	P (mm)	Flanges	Code	€
200	280	150	280	220	UNI PN10	CLVP10200BL	349,00
250	400	330	350	345	UNI PN10	CLVP10250BL	515,00
315	450	380	400	410	UNI PN10	CLVP10315BL	738,00
400	540	410	485	495	UNI PN10	CLVP10400BL	787,00
500	680	530	590	620	UNI PN10	CLVP10500BL	883,00
630	770	560	715	730	UNI PN10	CLVP10630BL	2.100,00

Mancano quote sul immagine

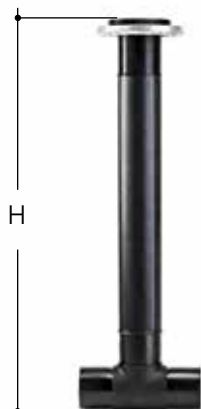

PN10 Flanged HDPE Line Hydrant

Flanged HDPE Line HYDRANT

Ø (mm)	DN (mm)	H (mm)	PN10 Code	€
110	100	1000	ITVP101100BL	212,00
125	100	1000	ITVP101250BL	303,00
140	100	1000	ITVP101400BL	355,00
160	150	1000	ITVP101600BL	390,00
180	150	1000	ITVP101800BL	513,00
200	150	1000	ITVP102000BL	617,00
225	150	1000	ITVP102250BL	667,00
250	150	1000	ITVP102500BL	883,00
280	150	1000	ITVP102800BL	1.017,00
315	150	1000	ITVP103150BL	1.063,00

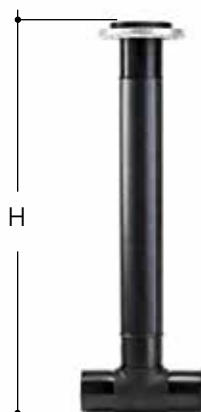

PN16 Flanged HDPE Line Hydrant

Flanged HDPE Line HYDRANT

Ø (mm)	DN (mm)	H (mm)	PN16 Code	€
110	100	1000	ITVP161100BL	223,00
125	100	1000	ITVP161250BL	319,00
140	100	1000	ITVP161400BL	373,00
160	150	1000	ITVP161600BL	410,00
180	150	1000	ITVP161800BL	590,00
200	150	1000	ITVP162000BL	709,00
225	150	1000	ITVP162250BL	767,00
250	150	1000	ITVP162500BL	1.016,00
280	150	1000	ITVP162800BL	1.169,00
315	150	1000	ITVP163150BL	1.223,00



PN10 Flanged HDPE Inlet Hydrant

Flanged HDPE Inlet HYDRANT

Ø (mm)	DN (mm)	H (mm)	PN10 Code	€
110	100	1000	ISVP101100BL	225,00
125	100	1000	ISVP101250BL	312,00
140	100	1000	ISVP101400BL	368,00
160	100	1000	ISVP101600BL	607,00
180	150	1000	ISVP101800BL	650,00
200	150	1000	ISVP102000BL	617,00
225	150	1000	ISVP102250BL	702,00
250	150	1000	ISVP102500BL	910,00
280	150	1000	ISVP102800BL	1.040,00
315	150	1000	ISVP103150BL	1.127,00



PN16 Flanged HDPE Inlet Hydrant

Flanged HDPE Inlet HYDRANT

Ø (mm)	DN (mm)	H (mm)	PN16 Code	€
110	100	1000	ISVP161100BL	237,00
125	100	1000	ISVP161250BL	328,00
140	100	1000	ISVP161400BL	387,00
160	100	1000	ISVP161600BL	419,00
180	150	1000	ISVP161800BL	698,00
200	150	1000	ISVP162000BL	748,00
225	150	1000	ISVP162250BL	807,00
250	150	1000	ISVP162500BL	1.047,00
280	150	1000	ISVP162800BL	1.196,00
315	150	1000	ISVP163150BL	1.296,00



PN10 Flanged HDPE End-of-Line Hydrant

Flanged HDPE End-of-Line HYDRANT

Ø (mm)	DN (mm)	H (mm)	PN10 Code	€
110	100	1000	ILVP101100BL	212,00
125	100	1000	ILVP101250BL	303,00
140	100	1000	ILVP101400BL	355,00
160	100	1000	ILVP101600BL	383,00
180	150	1000	ILVP101800BL	513,00
200	150	1000	ILVP102000BL	617,00
225	150	1000	ILVP102250BL	667,00
250	150	1000	ILVP102500BL	883,00
280	150	1000	ILVP102800BL	1.017,00
315	150	1000	ILVP103150BL	1.063,00



Flanged HDPE end-of-line hydrant PN16

Flanged HDPE End-of-Line HYDRANT

Ø (mm)	DN (mm)	H (mm)	PN16 Code	€
110	100	1000	ILVP161100BL	223,00
125	100	1000	ILVP161250BL	319,00
140	100	1000	ILVP161400BL	373,00
160	100	1000	ILVP161600BL	410,00
180	150	1000	ILVP161800BL	590,00
200	150	1000	ILVP162000BL	709,00
225	150	1000	ILVP162250BL	767,00
250	150	1000	ILVP162500BL	1.016,00
280	150	1000	ILVP162800BL	1.169,00
315	150	1000	ILVP163150BL	1.223,00

SPARE PARTS AND ACCESSORIES



Pressure seal

Rubber gasket

D (mm)	Code	€
40	GUARP040	1,10
50	GUARP050	1,30
63	GUARP063	1,53
75	GUARP075	2,10
90	GUARP090	2,73
110	GUARP110	3,83
125	GUARP125	4,60
140	GUARP140	5,60
160	GUARP160	7,20
180	GUARP180	9,37
200	GUARP200	10,07
225	GUARP225	15,80
250	GUARP250	17,43
280	GUARP280	25,33
315	GUARP315	31,13
355	GUARP355	42,70
400	GUARP400	52,00



Slippery

1 litre jar

U.M. jar	Code	€
Lit. 1	78001	29,67

Conditions of Supply

- **INTRODUCTORY STATEMENT:** our supplies include the products specified in our Sales confirmation and are governed by the following Terms and Conditions which the Customer declares to understand and to accept, except for possible derogations stated in an explicitly written agreement. In particular all foreign supplies will be governed by INCOTERMS, as defined by the International Chamber of Commerce.
- **PRODUCTS:** to prevent regrettable misunderstandings, **it is advisable to refer to the nomenclature and codes of our catalogues and/or price lists** for the identification of our products. The items featuring an asterisk (*), though currently on hand, are not included in our wide range of products for which stock rebuild is scheduled. Therefore our order acceptance depends upon the actual availability of the product.
- **PACKAGING:** to speed-up delivery and to facilitate warehousing at the Customer's, we reserve the right to convert the ordered quantities into multiples of the standard packages, as shown in our price list next to each item.
- **MINIMUM PURCHASE:** for orders involving a net amount of less than € 516,46 we will charge € 31 as partial recovery of the handling costs.
- **PRICES:** prices will be those in force at the time when the order was placed, except in case of forward delivery. In the latter case, the prices in force at the time of shipment will be invoiced. Our prices include normal packing; special packing, if required by the customer will be charged at cost price.
- **DELIVERY:** delivery is intended ex our Warehouse or Stores and is normally prompt, subject to being unsold. The anticipated delivery terms for unavailable items will be indicated, but these will be in no way binding or firm. If these delivery schedules cannot be kept for any reason whatsoever, the Purchaser can cancel the order only if the delay exceeds three months from the anticipated delivery date stated in our Order Confirmation. After this time lapse, we too shall be entitled to cancel any orders for items which delayed deliveries due to serious production problems.
- **SHIPMENT:** if the mode of shipment is not specifically indicated by the Customer, shipment will be effected as deemed most suitable by us. Even if the goods are sold free to destination, their transport will be at the Customer's risk. Insurance coverage will only be effected if specifically requested by the Customer.
- **PAYMENT:** the Customer cannot, for any reason whatsoever, defer payments beyond the established dates. Furthermore, we shall be fully entitled to charge interests in arrears on any and all delayed payments. These interests will be based upon the discount rate in force at that time in Italy, plus 3 unit % .
 - Unless otherwise specified, payments shall be made by opening of an irrevocable credit at call (for Foreign Countries).
 - Unless otherwise specified, payment shall be telegraphic transfer not later than 30 days after the date of invoicing (for Italy)
- **OWNERSHIP CLAUSE:** the products supplied by us will remain our property until fully paid for.
- **GUARANTEE CLAUSE:** we guarantee the good quality of our products in compliance with the standards publicized in our catalogues. However, our guarantee is limited to the repair and/or replacement of our materials, excluding any other liability, in particular for damages caused in any way whatsoever by utilization of our products. This guarantee terminates and will be no longer valid:
 - one year after the delivery of the material in question;
 - if the material is used in other way than the operating conditions specified by us;
 - if the materials are modified by people not belonging to our Company. On this subject, it should be noted that the Purchaser will incur all liabilities provided by Law for any modification of our products.We shall be duly informed about any accidents in which our products are involved and such accidents shall be reported to us immediately and within 24 Hours of their occurrence.
- **CLAIMS:** only complaints/claims reaching us by registered letter within 30 days after invoicing date will be taken into consideration. In particular, we will not accept any materials returned to us, unless their reshipment - free at our warehouses - has been duly authorized by our appropriate executive.
- **DISPUTES:** any disputes which cannot be amicably settled or settled by a court of arbitration, shall be handled by the Court of Genoa which will have jurisdiction.
- **CUSTOMER SERVICE:** our Technical and Commercial Services are available to all our Customers to provide any information on the characteristics and application sectors of our products.

The above General Terms and Conditions may be changed without previous notice.

All information contained in this collection are given in good faith and are correct at date of publication thereof.

The drawings and photographs contained in this price list are provided for illustrative purposes.

FIP Formatura Iniezione Polimeri

Via Occhiobello, 732

45024 Fiesso Umbertiano (Rovigo) Italia

Tel +39 0425 745511

sales.lareter@alixaxis.com

www.alixaxis.it

