

Raccordi BS



RACCORDI PER INCOLLAGGIO
E FILETTATI



RACCORDI BS

Serie di raccordi destinati al convogliamento di fluidi in pressione con sistema di giunzione per incollaggio e per filettatura secondo British Standard.

RACCORDI PER INCOLLAGGIO E FILETTATI

| Specifiche tecniche | |
|---------------------------|---|
| Gamma dimensionale | d 1/2" ÷ 8" |
| Pressione nominale | fino a 15 bar con acqua a 20° C |
| Campo di temperatura | 0 °C ÷ 60 °C |
| Standard di accoppiamento | Incollaggio: BS 4346-1, ASTM D 2467, JIS K 6743, ISO 727, EN ISO 15493, EN ISO 1452 Accoppiabile con tubi secondo ISO 7, ASTM D 2464, JIS B 0203 Filettatura: ISO 7, EN 10226-1/2, EN ISO 1452, EN ISO 15493, DIN 8062, ASTM D 1785, JIS K6741 Flangiatura: BS 10 Tab. E |
| Riferimenti normativi | Criteri Costruttivi: ISO 7, ASTM D 2464, JIS B 0203, EN ISO 1452, EN ISO 15493 Metodi e requisiti dei test: BS 4346-1 Criteri di installazione: DVS 2204, DVS 2221, UNI 11242 |
| Materiale raccordi | PVC-U Grigio scuro RAL 7011 |
| Materiali tenuta | EPDM |

DATI TECNICI

VARIAZIONE DELLA PRESSIONE IN FUNZIONE DELLA TEMPERATURA

Per acqua o fluidi non pericolosi nei confronti dei quali il materiale è classificato CHIMICAMENTE RESISTENTE (aspettativa di vita 25 anni). In altri casi è richiesta un'adeguata diminuzione della pressione nominale PN.

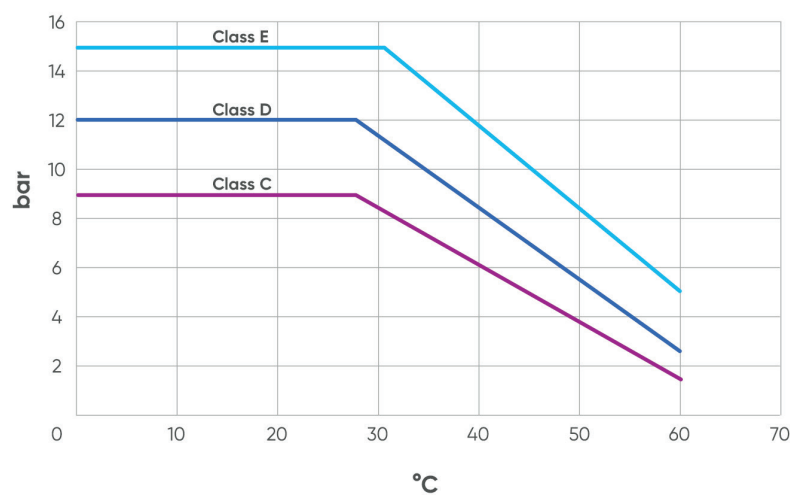

DIMENSIONI

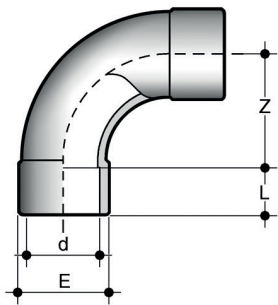

SLV

Curva a 90° GRANDE RAGGIO (R=2D) estremità a bicchiere per incollaggio

| d | PN | E | L | Z | g | Codice |
|-------|----|----|----|-----|------|--------|
| 2"1/2 | 15 | 94 | 44 | 150 | 1000 | SIV075 |

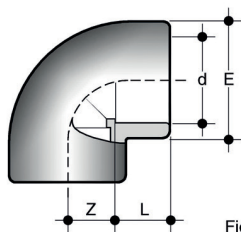
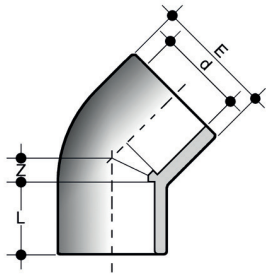

Fig. A

GLV

Gomito a 90° estremità a bicchiere per incollaggio

| d | PN | E | L | Z | g | Codice |
|-------|----|-----|-------|-------|------|--------|
| 1/2" | 15 | 27 | 16,5 | 10,5 | 15 | GLV012 |
| 3/4" | 15 | 33 | 19,5 | 13,5 | 30 | GLV034 |
| 1" | 15 | 41 | 22,5 | 17 | 45 | GLV100 |
| 1"1/4 | 15 | 54 | 27 | 21,5 | 110 | GLV114 |
| 1"1/2 | 15 | 61 | 31 | 27 | 160 | GLV112 |
| 2" | 15 | 76 | 38 | 33,5 | 340 | GLV200 |
| 2"1/2 | 15 | 90 | 44 | 40,5 | 427 | GIV075 |
| 3" | 15 | 108 | 51 | 48 | 768 | GLV300 |
| 4" | 15 | 131 | 63 | 58 | 972 | GLV400 |
| 6" | 12 | 186 | 86 | 82 | 2920 | GLV600 |
| 8" | 12 | 257 | 115,5 | 169,5 | 8850 | GLV800 |



HLV

Gomito a 45° estremità a bicchiere per incollaggio

| d | PN | E | L | Z | g | Codice |
|--------|----|-------|------|------|-----|--------|
| 1/2" | 15 | 27 | 16,5 | 5 | 13 | HLV012 |
| 3/4" | 15 | 33 | 19,5 | 5,5 | 20 | HLV034 |
| 1" | 15 | 41 | 22,5 | 7 | 45 | HLV100 |
| 1 1/4" | 15 | 50 | 26 | 10,5 | 85 | HLV114 |
| 1 1/2" | 15 | 61 | 31 | 11,5 | 155 | HLV112 |
| 2" | 15 | 76 | 38 | 14 | 291 | HLV200 |
| 2 1/2" | 15 | 90 | 44 | 17 | 315 | HIV075 |
| 3" | 15 | 107,5 | 51 | 21,5 | 565 | HLV300 |
| 4" | 15 | 131 | 61 | 26 | 740 | HLV400 |

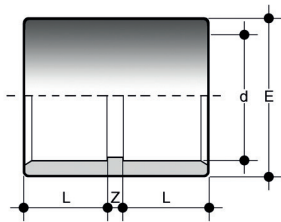

MLV

Manicotto estremità a bicchiere per incollaggio

| d | PN | E | L | Z | g | Codice |
|--------|----|-------|-------|-----|------|--------|
| 1/2" | 15 | 27 | 16,5 | 2 | 13 | MLV012 |
| 3/4" | 15 | 33 | 19,5 | 2 | 15 | MLV034 |
| 1" | 15 | 41 | 22,5 | 2 | 36 | MLV100 |
| 1 1/4" | 15 | 50 | 26 | 3 | 58 | MLV114 |
| 1 1/2" | 15 | 61 | 31 | 3 | 118 | MLV112 |
| 2" | 15 | 76 | 38 | 3 | 206 | MLV200 |
| 2 1/2" | 15 | 90 | 44 | 4 | 250 | MIV075 |
| 3" | 15 | 108 | 50,5 | 5,5 | 420 | MLV300 |
| 4" | 15 | 131 | 63 | 5 | 680 | MLV400 |
| 6" | 12 | 194,5 | 90 | 10 | 1800 | MLV600 |
| 8" | 12 | 257 | 115,5 | 12 | 4950 | MLV800 |

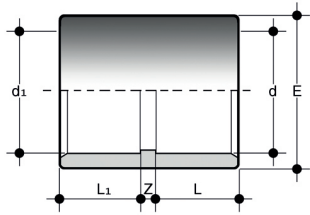

MILV

Manicotto MM/INCH estremità piane, una a bicchiere per incollaggio su tubi metrici, l'altra a bicchiere per incollaggio su tubi in pollici

| d x d ₁ | PN | E | L | L ₁ | Z | g | Codice |
|--------------------|----|-----|----|----------------|-----|-----|------------|
| 20 x 1/2" | 15 | 27 | 16 | 16,5 | 2,5 | 12 | MILV020012 |
| 25 x 3/4" | 15 | 33 | 19 | 19,5 | 2,5 | 22 | MILV025034 |
| 32 x 1" | 15 | 41 | 22 | 22,5 | 2,5 | 44 | MILV032100 |
| 40 x 1 1/4" | 15 | 50 | 26 | 27 | 2,0 | 65 | MILV040114 |
| 50 x 1 1/2" | 15 | 61 | 31 | 30 | 4,0 | 125 | MILV050112 |
| 63 x 2" | 15 | 76 | 38 | 36 | 5,0 | 210 | MILV063200 |
| 75 x 2 1/2" | 15 | 90 | 44 | 44 | 4,0 | 250 | MIV075 |
| 90 x 3" | 15 | 108 | 51 | 50,5 | 5,5 | 438 | MILV090300 |
| 110 x 4" | 15 | 131 | 61 | 63 | 4,0 | 852 | MILV110400 |

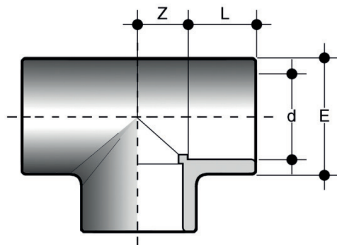

TLV

Ti a 90° estremità a bicchiere per incollaggio

| d | PN | E | L | Z | g | Codice |
|--------|----|-----|-------|------|-------|--------|
| 1/2" | 15 | 27 | 16,5 | 10,5 | 26 | TLV012 |
| 3/4" | 15 | 33 | 19,5 | 13,5 | 30 | TLV034 |
| 1" | 15 | 41 | 22,5 | 17 | 55 | TLV100 |
| 1 1/4" | 15 | 50 | 26 | 22 | 90 | TLV114 |
| 1 1/2" | 15 | 61 | 31 | 27 | 257 | TLV112 |
| 2" | 15 | 76 | 38 | 33,5 | 495 | TLV200 |
| 2 1/2" | 15 | 90 | 44 | 40,5 | 560 | TIV075 |
| 3" | 15 | 108 | 51 | 48 | 970 | TLV300 |
| 4" | 15 | 131 | 63 | 59 | 1260 | TLV400 |
| 6" | 12 | 186 | 86 | 82 | 3855 | TLV600 |
| 8" | 12 | 257 | 115,5 | 116 | 10500 | TLV800 |

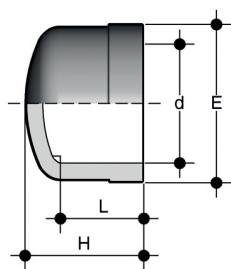

CLV

Calotta estremità a bicchiere per incollaggio

| d | PN | E | L | Z | g | Codice |
|-------|----|-----|------|-----|-----|--------|
| 1/2" | 15 | 28 | 16 | 4 | 49 | CLV012 |
| 3/4" | 15 | 33 | 19,5 | 2 | 15 | CLV034 |
| 1" | 15 | 41 | 22,5 | 2 | 36 | CLV100 |
| 1"1/4 | 15 | 50 | 26 | 3 | 58 | CLV114 |
| 1"1/2 | 15 | 61 | 31 | 3 | 118 | CLV112 |
| 2" | 15 | 76 | 38 | 3 | 206 | CLV200 |
| 2"1/2 | 15 | 90 | 44 | 4 | 250 | CIV075 |
| 3" | 15 | 108 | 50,5 | 5,5 | 420 | CLV300 |
| 4" | 15 | 131 | 63 | 5 | 680 | CLV400 |

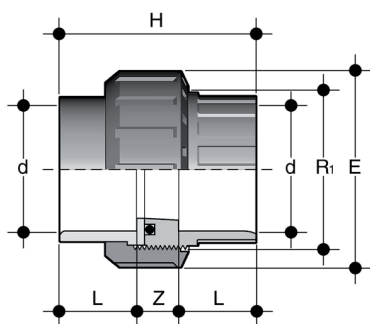

BLV

Bocchettone estremità a bicchiere per incollaggio, guarnizione O-Ring in EPDM

| d | PN | R ₁ | E | H | L | Z | g | Codice |
|--------|----|----------------|------|----|----|----|-----|---------|
| 1/2" | 15 | 1" | 40.5 | 45 | 16 | 13 | 39 | BLV012E |
| 3/4" | 15 | 1 1/4" | 50 | 51 | 19 | 13 | 65 | BLV034E |
| 1" | 15 | 1 1/2" | 57.5 | 57 | 22 | 13 | 94 | BLV100E |
| 1 1/4" | 15 | 2" | 71.5 | 67 | 26 | 15 | 150 | BLV114E |
| 1 1/2" | 15 | 2 1/4" | 79 | 79 | 31 | 17 | 190 | BLV112E |
| 2" | 15 | 2 3/4" | 98 | 98 | 38 | 21 | 400 | BLV200E |

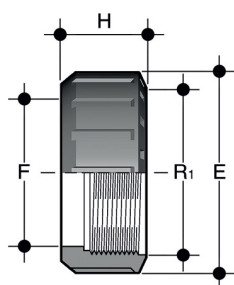

EFV

Ghiera con filettatura cilindrica per bocchettoni tipo BIV, BIFV, BFV, BLV, BIRV, BIFOV, BIROV, BIFXV, BIRXV.

| R | d BIV | PN | E | F | H | g | Codice |
|--------|-------|----|-----|-----|----|-----|--------|
| 1/2" | - | 16 | 27 | 17 | 24 | 8 | EFV012 |
| 3/4" | 16 | 16 | 33 | 22 | 21 | 9 | EFV034 |
| 1" | 20 | 16 | 41 | 28 | 22 | 13 | EFV100 |
| 1 1/4" | 25 | 16 | 50 | 36 | 25 | 22 | EFV114 |
| 1 1/2" | 32 | 16 | 58 | 42 | 27 | 30 | EFV112 |
| 2" | 40 | 16 | 72 | 53 | 30 | 50 | EFV200 |
| 2 1/4" | 50 | 16 | 79 | 59 | 34 | 68 | EFV214 |
| 2 1/2" | - | 16 | 90 | 68 | 36 | 95 | EFV212 |
| 2 3/4" | 63 | 16 | 98 | 74 | 38 | 120 | EFV234 |
| 3 1/2" | 75 | 10 | 120 | 93 | 45 | 198 | EFV312 |
| 4" | 90 | 10 | 135 | 106 | 52 | 278 | EFV400 |
| 5" | 110 | 10 | 163 | 129 | 60 | 448 | EFV500 |

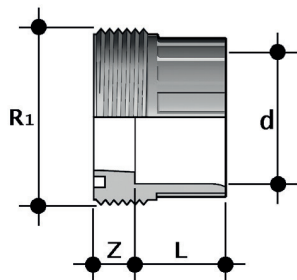

F/BLV

Pezzo fisso per incollaggio serie BS per bocchettoni tipo: BIV, BIFV, BFV, BLV, BIRV, BIFOV, BIROV, BIFXV, BIRXV

| d | R ₁ | PN | L | Z | g | Codice |
|-------|----------------|----|----|----|-------|---------|
| 1/2" | 1" | 15 | 16 | 10 | 12,5 | FBLV012 |
| 3/4" | 1"1/4 | 15 | 19 | 10 | 22,5 | FBLV034 |
| 1" | 1"1/2 | 15 | 22 | 10 | 30 | FBLV100 |
| 1"1/4 | 2" | 15 | 26 | 12 | 52 | FBLV114 |
| 1"1/2 | 2"1/2 | 15 | 31 | 14 | 69,5 | FBLV112 |
| 2" | 2"3/4 | 15 | 38 | 19 | 133,5 | FBLV200 |

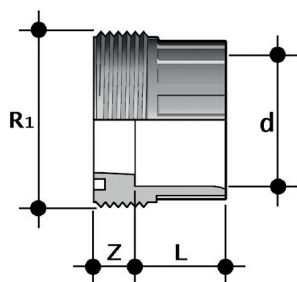

F/BIV

Pezzo fisso per incollaggio serie metrica per bocchettoni tipo: BIV, BIFV, BFV, BLV, BIRV, BIFOV, BIROV, BIFXV, BIRXV

| d | R ₁ | PN | L | Z | g | Codice |
|-----|----------------|----|----|----|-----|---------|
| 16 | 3/4" | 16 | 14 | 10 | 9 | FBIV016 |
| 20 | 1" | 16 | 16 | 10 | 13 | FBIV020 |
| 25 | 1"1/4 | 16 | 19 | 10 | 25 | FBIV025 |
| 32 | 1"1/2 | 16 | 22 | 10 | 31 | FBIV032 |
| 40 | 2" | 16 | 26 | 12 | 58 | FBIV040 |
| 50 | 2"1/4 | 16 | 31 | 14 | 63 | FBIV050 |
| 63 | 2"3/4 | 16 | 38 | 19 | 119 | FBIV063 |
| 75 | 3"1/2 | 10 | 44 | 18 | 230 | FBIV075 |
| 90 | 4" | 10 | 51 | 18 | 290 | FBIV090 |
| 110 | 5" | 10 | 61 | 18 | 500 | FBIV110 |

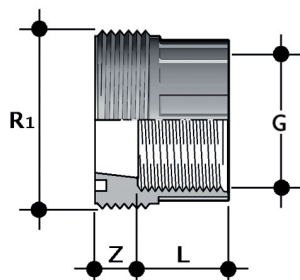

F/BFV

Pezzo fisso estremità femmina filettata BSP per bocchettoni tipo: BIV, BIFV, BFV, BLV, BIRV, BIFOV, BIROV, BIFXV, BIRXV

| G | R ₁ | PN | L ₁ | Z | g | Codice |
|--------|----------------|----|----------------|------|-----|---------|
| 3/8" | 3/4" | 16 | 11,4 | 12,6 | 8 | FBFV038 |
| 1/2" | 1" | 16 | 15 | 11 | 13 | FBFV012 |
| 3/4" | 1 1/4" | 16 | 16,3 | 12,7 | 22 | FBFV034 |
| 1" | 1 1/2" | 16 | 19,1 | 12,9 | 32 | FBFV100 |
| 1 1/4" | 2" | 16 | 21,4 | 16,6 | 57 | FBFV114 |
| 1 1/2" | 2 1/4" | 16 | 21,4 | 16,5 | 64 | FBFV112 |
| 2" | 2 3/4" | 16 | 25,7 | 20,5 | 122 | FBFV200 |

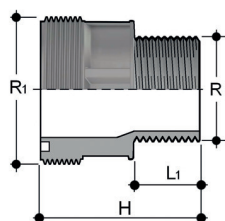

F/BRV

Pezzo fisso estremità maschio filettata BSP per bocchettoni tipo: BIV, BIFV, BFV, BLV, BIRV, BIFOV, BIROV, BIFXV, BIRXV

| R | R ₁ | PN | L ₁ | g | Codice |
|--------|----------------|----|----------------|-----|------------|
| 1 1/2" | 2 1/4" | 16 | 22,5 | 100 | FBRV112214 |
| 2" | 2 1/4" | 16 | 27 | 120 | FBRV200214 |
| 2" | 2 3/4" | 16 | 27 | 175 | FBRV200234 |

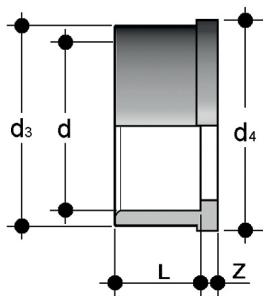

Q/BLV

Pezzo folle per incollaggio serie BS per bocchettoni tipo: BIV, BIFV, BFV, BLV, BIRV, BIFOV, BIROV, BIFXV, BIRXV

| d | PN | d ₃ | d ₄ | L | Z | g | Codice |
|-------|----|----------------|----------------|----|---|----|---------|
| 1/2" | 15 | 27,5 | 30,1 | 16 | 3 | 8 | QBLV012 |
| 3/4" | 15 | 36 | 38,8 | 19 | 3 | 13 | QBLV034 |
| 1" | 15 | 41,5 | 44,7 | 22 | 3 | 19 | QBLV100 |
| 1"1/4 | 15 | 53 | 56,5 | 26 | 3 | 32 | QBLV114 |
| 1"1/2 | 15 | 59 | 62,6 | 31 | 3 | 46 | QBLV112 |
| 2" | 15 | 74 | 78,4 | 38 | 3 | 86 | QBLV200 |

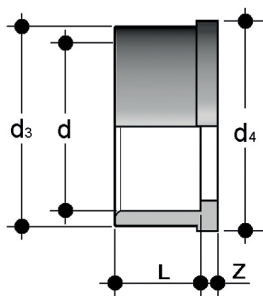

Q/BAV

Pezzo folle per incollaggio serie ASTM per bocchettoni tipo: BIV, BIFV, BFV, BLV, BIRV, BIFOV, BIROV, BIFXV, BIRXV

| d | PN | d ₃ | d ₄ | L | Z | g | Codice |
|-------|----|----------------|----------------|------|-----|------|---------|
| 1/2" | 16 | 27,5 | 30,1 | 22,7 | 3,5 | 15,5 | QBAV012 |
| 3/4" | 16 | 36 | 38,8 | 25,9 | 3,7 | 22,5 | QBAV034 |
| 1" | 16 | 41,5 | 44,7 | 29,2 | 3 | 32,5 | QBAV100 |
| 1"1/4 | 16 | 53 | 56,5 | 32 | 5 | 57 | QBAV114 |
| 1"1/2 | 16 | 59 | 62,6 | 35 | 5 | 78 | QBAV112 |
| 2" | 16 | 74 | 78,4 | 38,5 | 5,5 | 130 | QBAV200 |

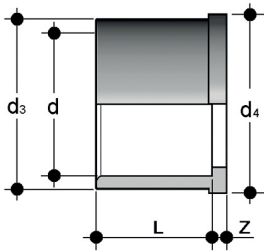

Q/BJV

Pezzo folle per incollaggio serie JIS per bocchettoni tipo: BIV, BIFV, BFV, BLV, BIRV, BIFOV, BIROV, BIFXV, BIRXV

| d | PN | d ₃ | d ₄ | L | Z | g | Codice |
|-------|----|----------------|----------------|------|-----|-----|---------|
| 1/2" | 16 | 27,5 | 30,1 | 30 | 3 | 16 | QBJV012 |
| 3/4" | 16 | 36 | 38,8 | 35 | 3,5 | 21 | QBJV034 |
| 1" | 16 | 41,5 | 44,7 | 40 | 3 | 40 | QBJV100 |
| 1"1/4 | 16 | 53 | 56,5 | 44 | 3 | 68 | QBJV114 |
| 1"1/2 | 16 | 59 | 62,6 | 55 | 4,5 | 105 | QBJV112 |
| 2" | 16 | 74 | 78,4 | 62,9 | 5,5 | 175 | QBJV200 |

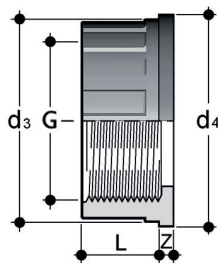

Q/BFV

Pezzo folle estremità filettata BSP per bocchettoni tipo: BIV, BIFV, BFV, BLV, BIRV, BIFOV, BIROV, BIFXV, BIRXV

| R | PN | d ₃ | d ₄ | L | Z | g | Codice |
|-------|----|----------------|----------------|------|-----|------|---------|
| 3/8" | 16 | 22 | 24 | 11,4 | 4,5 | 4,5 | QBFV038 |
| 1/2" | 16 | 27,5 | 30,1 | 15 | 5 | 8,5 | QBFV012 |
| 3/4" | 16 | 36 | 38,8 | 16,3 | 5 | 15,5 | QBFV034 |
| 1" | 16 | 41,5 | 44,7 | 19,1 | 5,5 | 21,0 | QBFV100 |
| 1"1/4 | 16 | 53 | 56,5 | 21,4 | 5,5 | 33,5 | QBFV114 |
| 1"1/2 | 16 | 59 | 62,6 | 21,4 | 5,5 | 40,0 | QBFV112 |
| 2" | 16 | 74 | 78,4 | 25,7 | 5,5 | 72,0 | QBFV200 |

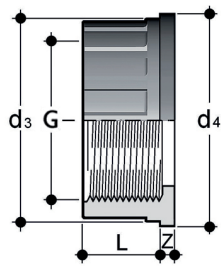

Q/BNV

Pezzo folle estremità femmina filettata NPT per bocchettoni tipo: BIV, BIFV, BFV, BLV, BIRV, BIFOV, BIROV, BIFXV, BIRXV

| G | PN | d ₃ | d ₄ | L | Z | g | Codice |
|--------|----|----------------|----------------|------|-----|-----|---------|
| 3/8" | 16 | 22 | 24 | 12,7 | 6,3 | 10 | QBNV038 |
| 1/2" | 16 | 27,5 | 30,1 | 17,8 | 5,2 | 15 | QBNV012 |
| 3/4" | 16 | 36 | 38,8 | 18 | 5,2 | 20 | QBNV034 |
| 1" | 16 | 41,5 | 44,7 | 22,6 | 5,7 | 30 | QBNV100 |
| 1 1/4" | 16 | 53 | 56,5 | 25,1 | 7,3 | 55 | QBNV114 |
| 1 1/2" | 16 | 59 | 62,6 | 24,7 | 7 | 70 | QBNV112 |
| 2" | 16 | 74 | 78,4 | 29,6 | 7,8 | 115 | QBNV200 |

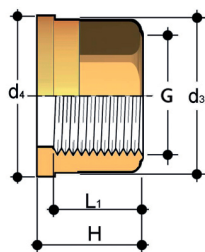

Q/BFO

Pezzo folle estremità femmina filettata BSP in Ottone per bocchettoni tipo: BIV, BIFV, BFV, BLV, BIRV, BIFOV, BIROV, BIFXV, BIRXV

| G | d ₃ | d ₄ | H | L ₁ | g | Codice |
|--------|----------------|----------------|------|----------------|-----|---------|
| 3/8" | 22 | 24 | 21,5 | 13,5 | 38 | QBFO038 |
| 1/2" | 27,5 | 30,1 | 22,5 | 16,5 | 60 | QBFO012 |
| 3/4" | 36 | 38,8 | 25,5 | 18,5 | 116 | QBFO034 |
| 1" | 41,5 | 44,7 | 27,5 | 19,5 | 144 | QBFO100 |
| 1 1/4" | 53 | 56,5 | 30,5 | 21,5 | 260 | QBFO114 |
| 1 1/2" | 59 | 62,6 | 33,5 | 23 | 325 | QBFO112 |
| 2" | 74 | 78,4 | 38,5 | 27 | 578 | QBFO200 |

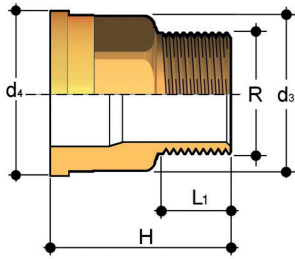

Q/BRO

Pezzo folle estremità maschio filettata BSP in Ottone per bocchettoni tipo: BIV, BIFV, BFV, BLV, BIRV, BIFOV, BIROV, BIFXV, BIRXV

| R | d ₃ | d ₄ | H | L ₁ | g | Codice |
|-------|----------------|----------------|------|----------------|-----|---------|
| 3/8" | 22 | 24 | 34,5 | 10,5 | 64 | QBRO038 |
| 1/2" | 27,5 | 30,1 | 39 | 13,5 | 105 | QBRO012 |
| 3/4" | 36 | 38,8 | 43,5 | 15 | 184 | QBRO034 |
| 1" | 41,5 | 44,7 | 48 | 17,5 | 251 | QBRO100 |
| 1"1/4 | 53 | 56,5 | 53 | 19,5 | 437 | QBRO114 |
| 1"1/2 | 59 | 62,6 | 56 | 19,5 | 545 | QBRO112 |
| 2" | 74 | 78,4 | 65,5 | 24 | 937 | QBRO200 |

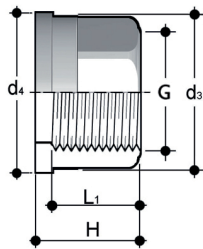

Q/BFX

Pezzo folle estremità femmina filettata BSP in Acciaio INOX A316L per bocchettoni tipo: BIV, BIFV, BFV, BLV, BIRV, BIFOV, BIROV, BIFXV, BIRXV

| G | d ₃ | d ₄ | H | L ₁ | g | Codice |
|-------|----------------|----------------|------|----------------|-----|---------|
| 3/8" | 22 | 24 | 21,5 | 13,5 | 34 | QBFX038 |
| 1/2" | 27,5 | 30,1 | 22,5 | 16,5 | 54 | QBFX012 |
| 3/4" | 36 | 38,8 | 25,5 | 18,5 | 104 | QBFX034 |
| 1" | 41,5 | 44,7 | 27,5 | 19,5 | 130 | QBFX100 |
| 1"1/4 | 53 | 56,5 | 30,5 | 21,5 | 234 | QBFX114 |
| 1"1/2 | 59 | 62,6 | 33,5 | 23 | 293 | QBFX112 |
| 2" | 74 | 78,4 | 38,5 | 27 | 520 | QBFX200 |

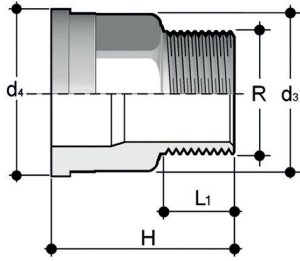

Q/BRX

Pezzo folle estremità maschio filettata BSP in Acciaio INOX A316L per bocchettoni tipo: BIV, BIFV, BFV, BLV, BIRV, BIFOV, BIROV, BIFXV, BIRXV

| R | d ₃ | d ₄ | H | L ₁ | g | Codice |
|-------|----------------|----------------|------|----------------|-----|---------|
| 3/8" | 22 | 24 | 34,5 | 10,5 | 58 | QBRX038 |
| 1/2" | 27,5 | 30,1 | 39 | 13,5 | 95 | QBRX012 |
| 3/4" | 36 | 38,8 | 43,5 | 15 | 166 | QBRX034 |
| 1" | 41,5 | 44,7 | 48 | 17,5 | 226 | QBRX100 |
| 1"1/4 | 53 | 56,5 | 53 | 19,5 | 393 | QBRX114 |
| 1"1/2 | 59 | 62,6 | 56 | 19,5 | 491 | QBRX112 |
| 2" | 74 | 78,4 | 65,5 | 24 | 843 | QBRX200 |

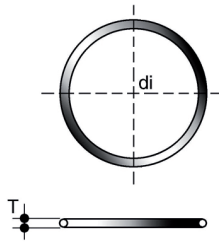

O-RING

Guarnizione per bocchettoni tipo BIV, BIFV, BFV, BLV, BIRV, BIFOV, BIROV, BIFXV, BIRXV.

| Union D | C | di | T | Codice | Codice |
|---------|------|--------|------|---------|---------|
| 16 | 3062 | 15,54 | 2,62 | OR3062E | OR3062F |
| 20 | 4081 | 20,22 | 3,53 | OR4081E | OR4081F |
| 25 | 4112 | 28,17 | 3,53 | OR4112E | OR4112F |
| 32 | 4131 | 32,93 | 3,53 | OR4131E | OR4131F |
| 40 | 6162 | 40,65 | 5,34 | OR6162E | OR6162F |
| 50 | 6187 | 47 | 5,34 | OR6187E | OR6187F |
| 63 | 6237 | 59,69 | 5,34 | OR6237E | OR6237F |
| 75 | 6300 | 75,57 | 5,34 | OR6300E | OR6300F |
| 90 | 6362 | 91,45 | 5,34 | OR6362E | OR6362F |
| 110 | 6450 | 113,67 | 5,34 | OR6450E | OR6450F |

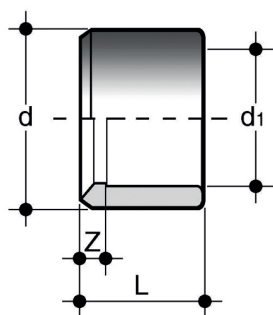

Fig. A

DLV

Bussola di riduzione estremità maschio per incollaggio (1° d di riferimento) estremità a bicchiere per incollaggio (d1 ridotto) (fig. A)

| d x d ₁ | PN | L | Z | g | Codice |
|--------------------|----|------|-----|-----|-----------|
| 1/2" x 3/8" | 15 | 16,5 | 2 | 3 | DLV012038 |
| 3/4" x 1/2" | 15 | 19,5 | 3 | 5,5 | DLV034012 |
| 1" x 1/2" | 15 | 22,5 | 6,5 | 18 | DLV100012 |
| 1" x 3/4" | 15 | 22,5 | 3 | 10 | DLV100034 |
| 1 1/4" x 1" | 15 | 27 | 4 | 19 | DLV114100 |
| 1 1/2" x 1" | 15 | 30 | 7,5 | 42 | DLV112100 |
| 1 1/2" x 1 1/4" | 15 | 31 | 4 | 20 | DLV112114 |
| 2" x 1 1/4" | 15 | 38 | 12 | 80 | DLV200114 |
| 2 1/2" x 2" | 15 | 43,5 | 7,5 | 100 | DLV212200 |
| 3" x 2 1/2" | 15 | 50,5 | 7 | 125 | DLV300212 |
| 4" x 3" | 15 | 63 | 12 | 331 | DLV400300 |
| 5" x 4" | 15 | 76 | 15 | 460 | DLV500400 |

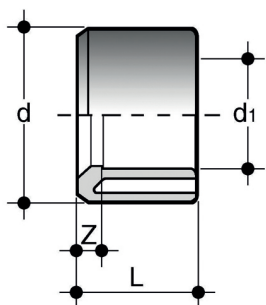
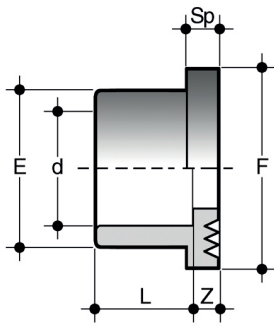

Fig. B

DLV

Bussola di riduzione estremità maschio per incollaggio (1° d di riferimento) estremità a bicchiere per incollaggio (d1 ridotto) (fig. B)

| d x d ₁ | PN | L | Z | g | Codice |
|--------------------|----|-------|------|------|-----------|
| 1 1/2" x 3/4" | 15 | 30 | 10 | 40 | DLV112034 |
| 2" x 1" | 15 | 36 | 7 | 50 | DLV200100 |
| 2" x 1 1/2" | 15 | 38 | 7 | 50 | DLV200112 |
| 3" x 1 1/2" | 15 | 50,5 | 20,5 | 200 | DLV300112 |
| 3" x 2" | 15 | 51 | 13 | 167 | DLV300200 |
| 4" x 2" | 15 | 63 | 27 | 370 | DLV400200 |
| 6" x 4" | 12 | 90 | 27 | 972 | DLV600400 |
| 8" x 6" | 12 | 115,5 | 26,5 | 1400 | DLV800600 |



QLV

Collare d'appoggio striato estremità a bicchiere per incollaggio, superfici di appoggio striate per controcollari QLV e guarnizioni piane QHV/X e QHV/Y. (QHV/Y solo in accoppiamento con Flange ISO/DIN "ODV e ODB")

| d | PN | E | F | L | Sp | Z | g | Codice |
|-------|----|-----|-----|-----|----|-----|------|--------|
| 2" | 15 | 76 | 90 | 38 | 9 | 4 | 112 | QLV200 |
| 2"1/2 | 15 | 90 | 106 | 44 | 10 | 3 | 165 | QRV075 |
| 3" | 15 | 108 | 125 | 51 | 11 | 5 | 273 | QLV300 |
| 4" | 15 | 131 | 150 | 61 | 12 | 5 | 439 | QLV400 |
| 6" | 12 | 188 | 216 | 86 | 16 | 5 | 1250 | QLV600 |
| 8" | 12 | 250 | 270 | 115 | 20 | 6,5 | 2150 | QLV800 |

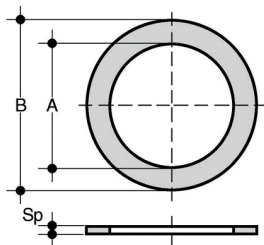

QHV/X

Guarnizione piana in EPDM e FKM per flangiatura secondo EN 1092

| d | DN | A | B | Sp | Codice | Codice |
|-------------|-----|-----|------|----|----------|----------|
| 16 | 10 | 16 | 27 | 2 | QHVX016E | QHVX016F |
| 20 - 1/2" | 15 | 20 | 32 | 2 | QHVX020E | QHVX020F |
| 25 - 3/4" | 20 | 24 | 38,5 | 2 | QHVX025E | QHVX025F |
| 32 - 1" | 25 | 32 | 48 | 2 | QHVX032E | QHVX032F |
| 40 - 1" 1/4 | 32 | 40 | 59 | 2 | QHVX040E | QHVX040F |
| 50 - 1" 1/2 | 40 | 50 | 71 | 2 | QHVX050E | QHVX050F |
| 63 - 2" | 50 | 63 | 88 | 2 | QHVX063E | QHVX063F |
| 75 - 2" 1/2 | 65 | 75 | 104 | 2 | QHVX075E | QHVX075F |
| 90 - 3" | 80 | 90 | 123 | 2 | QHVX090E | QHVX090F |
| 110 - 4" | 100 | 110 | 148 | 3 | QHVX110E | QHVX110F |
| 125 | 125 | 125 | 166 | 3 | QHVX125E | QHVX125F |
| 140 | 125 | 140 | 186 | 3 | QHVX140E | QHVX140F |
| 160 - 6" | 150 | 160 | 211 | 3 | QHVX160E | QHVX160F |
| 200 | 200 | 200 | 252 | 4 | QHVX200E | - |
| 225 - 8" | 200 | 225 | 270 | 4 | QHVX225E | - |
| 250 | 250 | 250 | 305 | 4 | QHVX250E | - |

prodotti di rivendita

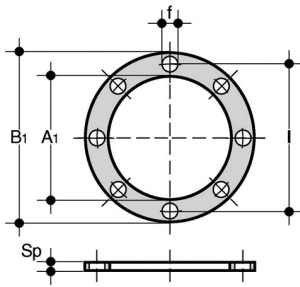

QHV/Y

Guarnizione piana in EPDM per flangiatura secondo EN 1092, autocentrante per foratura PN 10/16 fino a DN 150 e PN 10 da DN 200

| d | DN | A ₁ | B ₁ | F | I | U | Sp | Codice |
|-------------|-----|----------------|----------------|----|-------|----|----|---------------|
| 20 - 1/2" | 15 | 17 | 95 | 14 | 65 | 4 | 2 | QHVV020E |
| 25 - 3/4" | 20 | 22 | 107 | 14 | 76,3 | 4 | 2 | QHVV025E |
| 32 - 1" | 25 | 28 | 117 | 14 | 86,5 | 4 | 2 | QHVV032E |
| 40 - 1" 1/4 | 32 | 36 | 142,5 | 18 | 101 | 4 | 2 | QHVV040E |
| 50 - 1" 1/2 | 40 | 45 | 153,3 | 18 | 111 | 4 | 2 | QHVV050E |
| 63 - 2" | 50 | 57 | 168 | 18 | 125,5 | 4 | 2 | QHVV063E |
| 75 - 2" 1/2 | 65 | 71 | 187,5 | 18 | 145,5 | 4 | 3 | QHVV075E |
| 90 - 3" | 80 | 84 | 203 | 18 | 160 | 8 | 3 | QHVV090E |
| 110 - 4" | 100 | 102 | 223 | 18 | 181 | 8 | 3 | QHVV110E |
| 125 | 125 | 132 | 250 | 18 | 210 | 8 | 3 | QHVV125EDN125 |
| 140 | 125 | 132 | 250 | 18 | 210 | 8 | 3 | QHVV140E |
| 160 - 6" | 150 | 152 | 288,5 | 22 | 241,5 | 8 | 4 | QHVV160E |
| 200 | 200 | 192 | 340 | 22 | 295 | 8 | 4 | QHVV200E |
| 225 - 8" | 200 | 215 | 340 | 22 | 295 | 8 | 4 | QHVV225E |
| 250 | 250 | 238 | 395 | 22 | 350 | 12 | 4 | QHVV250E |
| 280 | 250 | 265 | 395 | 22 | 350 | 12 | 4 | QHVV280E |
| 315 | 300 | 290 | 462 | 22 | 400 | 12 | 4 | QHVV315E |
| 355 | 350 | 337 | 500 | 22 | 460 | 16 | 2 | QHVV355E |
| 400 | 400 | 384 | 555 | 22 | 515 | 16 | 2 | QHVV400E |

prodotti di rivendita

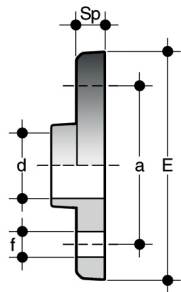

FLV

Flangia BS 10, tabella E, a bicchiere per incollaggio (per le dimensioni delle guarnizioni vedi QHV/X)

| d | PN | a | E | f | L | Sp | U | Z | g | Codice |
|--------|----|------|-----|----|------|------|---|-----|------|--------|
| 1/2" | 15 | 67 | 95 | 14 | 16,5 | 11 | 4 | 5 | 100 | FLV012 |
| 3/4" | 15 | 73 | 105 | 14 | 19,5 | 12 | 4 | 5 | 140 | FLV034 |
| 1" | 15 | 82,5 | 115 | 14 | 22,5 | 14 | 4 | 5 | 200 | FLV100 |
| 1 1/4" | 15 | 87,5 | 125 | 14 | 27 | 15 | 4 | 5 | 265 | FLV114 |
| 1 1/2" | 15 | 98,5 | 140 | 14 | 31 | 16 | 4 | 5 | 350 | FLV112 |
| 2" | 15 | 115 | 165 | 18 | 38 | 18 | 4 | 5 | 500 | FLV200 |
| 3" | 15 | 146 | 200 | 18 | 51 | 20,5 | 4 | 5,5 | 860 | FLV300 |
| 4" | 15 | 178 | 220 | 18 | 63 | 22,5 | 8 | 5,5 | 1100 | FLV400 |

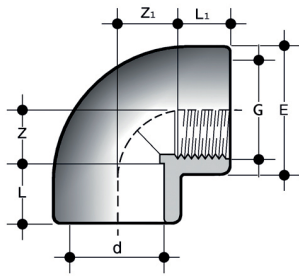

GLFV

Gomito a 90° estremità d a bicchiere per incollaggio, estremità G femmina filettata

| d x G | PN | E | L | L ₁ | Z | Z ₁ | g | Codice |
|-----------------|----|-----|------|----------------|------|----------------|------|------------|
| 1/2" x 1/2" | 15 | 27 | 16,5 | 15 | 10,5 | 12 | 13 | GLFV012 |
| 3/4" x 3/4" | 15 | 33 | 19,5 | 16,3 | 13,5 | 16,7 | 25 | GLFV034 |
| 1" x 1" | 15 | 41 | 22,5 | 19,1 | 17 | 20,4 | 55 | GLFV100 |
| 1 1/2" x 1 1/2" | 15 | 61 | 31 | 21,4 | 27 | 36,6 | 170 | GLFV112 |
| 2" x 2" | 15 | 76 | 38 | 25,7 | 33,5 | 45,8 | 340 | GLFV200 |
| 2 1/2" x 2 1/2" | 12 | 90 | 44 | 30,2 | 40,5 | 54,3 | 420 | GIFV075212 |
| 3" x 3" | 12 | 108 | 51 | 33,3 | 48 | 65,7 | 750 | GLFV300 |
| 4 x 4" | 12 | 131 | 63 | 39,3 | 58 | 81,7 | 1050 | GLFV400 |

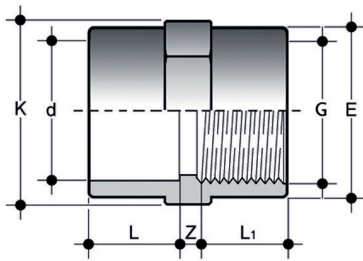

MLFV

Manicotto estremità d a bicchiere per incollaggio, estremità G femmina filettata

| d x G | PN | E | K | L | L ₁ | Z | g | Codice |
|-----------------|----|-----|-----|------|----------------|------|-----|---------------|
| 1/2" x 1/2" | 15 | 27 | 24 | 16 | 15 | 4 | 15 | MLFV012 |
| 3/4" x 3/4" | 15 | 33 | 29 | 19,5 | 16,3 | 5,2 | 25 | MLFV034 |
| 1" x 1" | 15 | 41 | 35 | 22,5 | 19,1 | 4,5 | 45 | MLFV100 |
| 1 1/4" x 1 1/4" | 15 | 50 | 43 | 27 | 21,4 | 4 | 65 | MLFV114 |
| 1 1/2" x 1 1/2" | 15 | 61 | 50 | 30 | 21,4 | 8 | 100 | MLFV112 |
| 2" x 2" | 15 | 76 | 61 | 36 | 25,7 | 9 | 160 | MLFV200 |
| 2 1/2" x 2 1/2" | 12 | 90 | 76 | 44 | 30,2 | 17,8 | 260 | DIFV090075212 |
| 3" x 3" | 12 | 108 | 108 | 51 | 33,3 | 22,7 | 449 | MLFV300 |

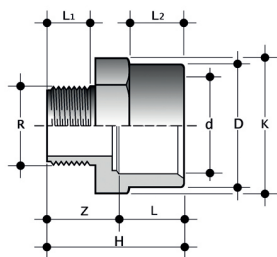

ILFV

Adattatore femmina/maschio estremità d a bicchiere per incollaggio, estremità G maschio filettata

| d x G | PN | H | K | L | L ₁ | Z | g | Codice |
|---------------|----|------|----|------|----------------|------|-----|---------|
| 1/2" x 1/2" | 15 | 37,5 | 30 | 16,5 | 15 | 21 | 20 | ILFV012 |
| 3/4" x 3/4" | 15 | 42 | 36 | 19,5 | 16,3 | 22,5 | 22 | ILFV034 |
| 1" x 1" | 15 | 47,5 | 46 | 22,5 | 19,1 | 25 | 25 | ILFV100 |
| 1"1/4 x 1"1/4 | 15 | 56,5 | 55 | 27 | 21,4 | 29,5 | 65 | ILFV114 |
| 1"1/2 x 1"1/2 | 15 | 62 | 65 | 31 | 21,4 | 31 | 98 | ILFV112 |
| 2" x 2" | 15 | 73 | 80 | 38 | 25,7 | 35 | 160 | ILFV200 |