

Settore a gomito 30° M/F

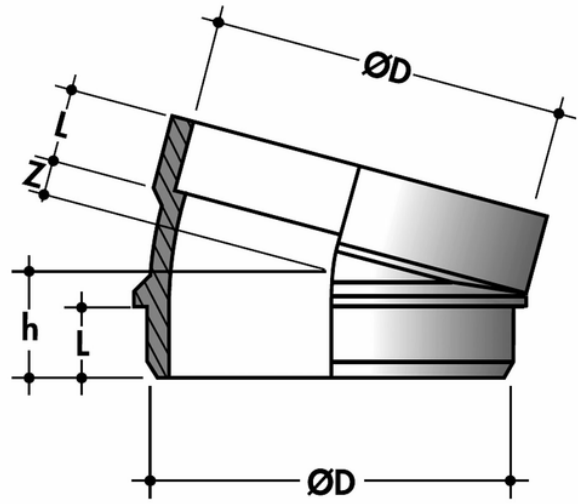

Codice	Ø (mm)
ST300NI	100