

S22AV - 24V AC - true union 2-way solenoid valve

2 way solenoid valve with ASTM female union ends for solvent welding.

Function: Normally closed. Power supply: 24V AC

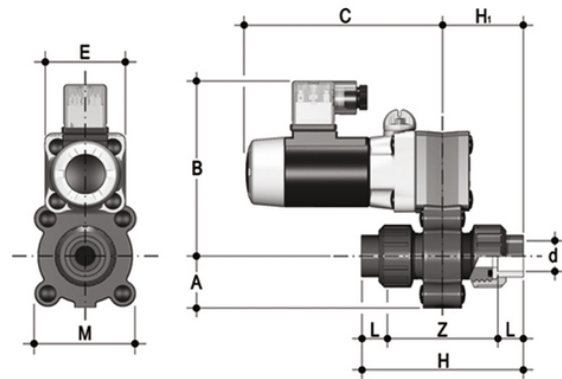

EPDM

Reference	d	DN	A	B	C	H	H ₁	L	Z	E	M	g
S22AV0812E024A	1/2"	8	34	115	130	116	58	22	72	54	67	1000
S22AV0838E024A	3/8"	8	34	115	130	109	55	19	71	54	67	1000
S22AV1012E024A	1/2"	10	34	115	130	116	58	22	72	54	67	1000
S22AV1038E024A	3/8"	10	34	115	130	109	55	19	71	54	67	1000
S22AV1512E024A	1/2"	15	34	115	130	116	58	22	72	54	67	1000
S22AV1538E024A	3/8"	15	34	115	130	109	55	19	71	54	67	1000

S22AV - 24V AC - true union 2-way solenoid valve

Reference	d	DN	A	B	C	H	H ₁	L	Z	E	M	g
S22AV0812F024A	1/2"	8	34	115	130	116	58	22	72	54	67	1000
S22AV0838F024A	3/8"	8	34	115	130	109	55	19	71	54	67	1000
S22AV1012F024A	1/2"	10	34	115	130	116	58	22	72	54	67	1000
S22AV1038F024A	3/8"	10	34	115	130	109	55	19	71	54	67	1000
S22AV1512F024A	1/2"	15	34	115	130	116	58	22	72	54	67	1000
S22AV1538F024A	3/8"	15	34	115	130	109	55	19	71	54	67	1000

S22AV – 24V AC – true union 2-way solenoid valve

- Installation flexibility and ease of maintenance: high-performance solenoid electric actuator with internal moving parts designed to exceed 5 million maintenance free operating cycles. Adjustable circular section coil with IP65 protection class.
 - DIN 43650 electrical connector supplied as standard: includes LED indicator light and rectifier (in the case of an AC coil).
 - Lever shutter in EPDM or FKM and lever in stainless steel.
 - Suitable for use with aggressive fluids: no metal component in contact with the fluid or the external environment; all the screws are covered by PE protection plugs.
 - Emergency override
-
- 2-Way PVC-U body
 - Installation flexibility and ease of maintenance: high-performance solenoid electric actuator designed to exceed 5 million maintenance-free operating cycles
 - Adjustable circular section coil with IP65 protection class.
 - Integrated override with the possibility of being installed in 3 different positions.
 - Lever shutter in EPDM or FKM and lever in stainless steel.
 - DIN 43650 electrical connector supplied as standard: includes LED indicator light and rectifier (in the case of an AC coil).